

ORIGINAL **IVX**[®]

INSTALLATION MANUAL



(Inside front cover of
IVX Installation Manual)

TABLE OF CONTENTS

General Description

General Description	1.1
Advanced Features	1.2
Standard Features	1.5
Specifications	1.9

Hardware Installation

General	2.1
Site Location	2.4
66 Block Wiring Diagram	2.6
Electrical Requirements	2.7
Port Card Installation	2.12
Expansion Cabinet Installation	2.13

Tutorial

System Parameters	3.1
CO Line Examples	3.1
Extension Examples	3.6
Department Examples	3.7
Auto Attendant Examples	3.12
Voice Mail Examples	3.18

System Programming

System Numbering Plan	4.3
Programming Overview	4.4
System Parameters	4.5
CO Line Programming	4.9
Extension Programming	4.13
Department Programming	4.16
Analog Port Programming	4.20
Auto Attendant Programming	4.23
Voice Mail Programming	4.29
Guest/Info Mailbox	4.30
Group Mailbox	4.32
Recording	4.34
MOH Programming	4.36
Reports	4.38

Trouble Shooting

Worksheet

Index

Warranty

In the event that any product proves to be defective in workmanship or materials within a period of **one year** from date of shipment, Estech Systems, Inc shall repair or replace the same at its option. Transportation will be the responsibility of the user/dealer. **In no event shall Estech Systems, Inc be liable for consequential or special damages, lost revenue, or user/dealer expenses arising out of or in connection with the use or performance of the products, whether based on contract, tort, or any other legal theory.** The following shall void the above warranty: malfunctions resulting from fire, accident, neglect, abuse or acts of God; use of improper electrical power; or repair of, tampering with or alteration of the products by anyone other than Estech Systems, Inc authorized personnel.

Regulatory Approvals

FCC Part 15– This equipment has been tested and found to comply with the limits for a Class A digital device, pursuant to Part 15 of the FCC Rules. These limits are designed to provide reasonable protection against harmful interference when the equipment is operated in a commercial environment. This equipment generates, and uses, and can radiate radio frequency energy and, if not installed and used in accordance with the instruction manual, may cause harmful interference to radio communications. Operation of this equipment in which case the user will be required to correct the interference at his/her own expense.

FCC Part 68– Registration Number 1T1USA-23770-MF-E

Safety– Complies with UL Standard 1459

REN– 0.08

GENERAL DESCRIPTION

IVX[®], an integrated voice exchange, is an advanced small business telephone system with built-in voice processing, automated attendant and voice-mail capability. The system's combined functions are controlled by a single processor and by a single set of proprietary operating system software. Its combined features/functions include:

- A 16 x 34 Digital Telephone System
- 10 Ports of Voice Mail
- Full Automated Attendant
- Automatic Call Distribution (ACD)
- Message on Hold
- Caller ID
- Call Traffic and Activity Reports

BACKGROUND

Virtually all other telephone/voice mail systems involve connecting two or more separate systems (usually from different manufacturers). Call processing by these different "boxes" must transfer callers back and forth from system to system, with each performing its operation only during the time that it is connected to the caller.



IVX IS DIFFERENT

IVX is a single system that performs ALL of these functions as one – by a single processor, storage medium and voice processing DSP. With no boundaries between these once separate tasks, IVX delivers the greatest possible efficiency and cost effectiveness.

SYSTEM CABINET

The compact, wall-mounted cabinet houses the processor, memory, and station interfaces. It is powered by a small external wall-mount transformer. The base unit is capable of supporting up to eight CO Lines, 16 Feature Phones, and two Analog Ports. A piggy-back expansion cabinet for an additional 8 x 16 configuration is easily added without increasing the system's "footprint".

FEATURE PHONES

The proprietary feature phones provide advanced call handling features, an LCD Display, and built-in speaker phone capability.

IVX ADVANCED FEATURES**TOTAL INTEGRATION**

IVX provides seamless operation and call processing – no hook-flash or call progress monitoring required, resulting in the fastest call processing available.

SIMPLIFIED SET-UP

Installing separate systems require that different programming techniques and data be interfaced creating potential problem isolation issues. IVX's combined functions require NO interface. IVX's programming incorporates interactive voice and LCD display prompts that virtually eliminate ambiguity and guesswork for the installer, administrator or user.

VERBAL USER GUIDE™

The combination of voice prompts and LCD Display interaction guides users through station and voice mail feature programming and operation.

VERBAL HELP KEY™

The HELP Key provides interactive voice and LCD explanations of user programming requirements and all commonly used phone features – virtually eliminating the need to consult the printed user guide.

VOICEMAIL KEY

A unique fixed key that provides for one-stroke immediate interface to the user's voice mail features. Direct access to a voice mail box is accomplished by pressing the VOICEMAIL Key from an idle station. Transferring an outside caller directly to a user's mailbox is as simple as pressing the VOICEMAIL Key followed by the appropriate station key.

LIVE RECORDING

During any conversation, a user can press the REC Key and record the conversation for later retrieval. Users can record personal reminders simply by lifting the handset and pressing the REC key on the phone – and any recording can be further handled the same as any other regular message.

QUICK GROUPS™

A user can leave a message in several user's mailboxes without having to create and manage the traditional group mailboxes. Simply press the VOICEMAIL Key, press the desired Station Keys (up to 16) to receive this message and record the message.

LIVE CALL SCREENING (MESSAGE MONITOR)

Allows a user to handle incoming calls in the same way as a home answering machine. If the user activates *Monitor Mode*, a call presented to the station will ring at the station (including during the personal greeting being played to the outside caller). When the caller begins leaving a message, his or her voice is also output to the user's speaker, giving the user the option of intercepting the call by simply lifting the handset or allowing the message to be completed to the user's mailbox.

MESSAGE-ON-HOLD (MOH)

MOH allows for traditional announcement / music to be continuously played to callers while on hold. Three generic messages-on-hold are permanently stored on disk – or, up to five custom recordings can easily be downloaded for use.

ON-HOLD DIALING

Because the MOH source is being generated by the system, DTMF receivers are able to continuously monitor the line – allowing callers on hold or in ACD queue to dial other options such as menu selections or the operator.

PERSONAL GREETING REMINDER

Users typically activate this feature to automatically play their personal greeting the first time the phone is used after extended absence ensuring removal of outdated greetings. They do have the option to keep as is, or to change it.

REMOTE SYSTEM SOFTWARE UPDATING

System updates are accomplished via a high-speed, built-in Modem. System software or built-in voice prompts can be factory updated via dial-up rather than by costly and time-consuming EPROM replacement. Dealers can also use the Modem port for remote real-time monitoring of system activity, debug, or update of configuration data.

GUEST EXTENSIONS

Employees that work outside of the office can be assigned *Guest Extensions* making it appear as if they have a live station in the office. **Example:** the normal extensions are numbered 100 to 115. Three outside sales reps are assigned Guest Extensions 301, 302, and 303. An outside caller dialing 301 at the main greeting would be forwarded directly to mailbox 301. Additionally, an inside user can transfer a caller directly to 301's mailbox by pressing a station key programmed for "extension" 301.

ACD CAPABILITY

Department Groups can be set up to provide sophisticated Automatic Call Distribution (ACD) features. Calls are presented to the longest Idle ACD agent or, if all agents are busy, callers can be held in queue and presented as agents become available. Possibilities include: Up to 10 agent groups with up to 16 agents in a group.

LCD DISPLAY

Display for users and idle agents indicates number of new and old messages waiting in voice mail. During retrieval of messages, the display shows the phone number (*if Caller ID is active) associated with the message being heard – plus a count-down display of the message duration. The display shows real time activity to ACD agents indicating how many calls are holding and the length of the longest holding call.

CALLER ID

With Caller ID service activated with the service provider, the name and/or number of the calling party will be displayed on incoming calls and during call waiting. Additionally, the Caller ID will be displayed with messages to facilitate automatic callback to the calling party. **Note:** Some limitation based on the service provider and the local dialing patterns may exist.

VISUAL PARK KEYS

These unique keys allow simplified “park & page” to lighted park keys appearing on all stations. No need for confusing park and retrieve codes. In addition, a dedicated hold key provides for exclusive hold.

911 ALERT

This feature provides immediate line access if any station with line access dials 911 to report an emergency. A message will be sent via the serial port indicating the start date, time, station number, and end-time of the 911. Additionally, a warning tone will sound at the operator station and the LCD display will show “911 CALL FROM X102 JOHN JAMES”.

STANDARD FEATURES

AUTO ATTENDANT

Auto Attendant is like having an extra staff member on board – or, it may allow freeing up an existing employee for other duties. Efficient call handling is assured by up to six menu levels, 40 audiotext branches, directory, Day/Night/Holiday modes, and primary and secondary answering capability.

However, selected stations (such as lobby phones, top executives, etc.) can be blocked from receiving calls directly from the Auto Attendant.

AUTOMATIC MAILBOX CREATION

From the moment an IVX system is up-and-running, mailboxes are automatically created with generic *greeting* and *forwarding* default values for all users – there's no waiting for users to record personal greetings. However, at that point, users are able to easily create their own custom greetings.

CALL STATISTICS

IVX tracks call activity by Line, Extension, Department, and System. Summary Reports that are easy to read and interpret are easily printed by the System Administrator.

CALL FORWARD: BUSY/NO ANSWER AND ALL CALLS

The Installer can easily control Call Forward Busy/No Answer for each station on the system – in both Day and Night Mode. In addition, individual user control their own Call Forward All Calls.

CALL PICK-UP

Pressing the dedicated PICK-UP Key and a user's Station Key or dialed extension number allows a user to intercept a ringing department or station – minimizing caller aggravation caused by unanswered ringing.

CALL TRANSFER (LIVE)

Both supervised and blind transfers are accomplished by pressing the destination Station Key– or by pressing the TRANS Key and the destination extension number.

CALL WAITING

A second call (indicated by an audible tone and a display indication) to an in-use station can be handled by the user much the same as they do at home with call-waiting...simply press the FLASH Key to toggle between calls – or hang-up and the other call will ring. Inside personnel can manually alert someone on his phone that a call is waiting or someone is waiting in the lobby, etc.

CLASS OF SERVICE

Service or features programmed for individual stations can be custom programmed from two levels – the *Installer* level, or the *Administrator* level. The *Installer* level carries the most authority and flexibility.

LINE GROUPS

Each outbound Line can be assigned to one of three groups (9, 8, or 7). Icons on a user's LCD display shows how many lines exist, whether or not each line is in use, and which line the user has accessed.

COMMON AUDIBLE

One of the system's Analog Ports can be designated to provide common audible (e.g. bell, chime, etc.) ringing to provide simplified line pick-up from any station.

CONFERENCE / ADD-ON

Up to 12 parties can be in conferences at the same time– up to four parties in a single conference. However, the originating extension must remain in the conference.

DAY / NIGHT OPERATION

Day/Night Main Greeting and call processing can be easily programmed for automatic operation. Alternatively, the operator can manually change between Day/Night/ Holiday/Automatic with the press of a key.

DELAYED RINGING

Delayed ringing options allow flexibility in how unanswered incoming calls are processed. For example, an incoming call intended for a sales person or department may be progressed to an administrator – and ultimately to a chime for any available person to answer. The feature can be programmed on a Line-by-Line basis to a live operator or for Auto Attendant answer as well as day/night/answer, or clock/calendar control.

DO NOT DISTURB (DND)

This function can be allowed or denied on a station-by-station basis by the System Administrator. If allowed, a user activates the feature with the single press of the DND key while the phone is idle. The DND Key also controls Wrap Time for ACD agents.

SOFT FEATURE KEYS

These sixteen lighted, programmable keys provide one-touch transfer to stations, mailboxes, or departments; direct line keys; speed dial; or other feature access.

EXTERNAL PAGING INTERFACE

CO Line connection or one of two pre-assigned analog ports also can be used for simplified connection to external overhead paging equipment.

FAX TRANSFER (AUTOMATIC)

If a FAX tone is detected upon answer by the Auto Attendant, the call will automatically be transferred to the analog port set as a FAX extension.

FLASH CONTROL

System programming of the flash duration provides for flexible usage behind Central Office switches, Centrex, or PBXs.

HANDS-FREE ANSWER

Station users also have the option to program their phone for hands-free answer (voice announce) for station-to-station calls.

HOLD RECALL

This feature gives flexibility in the amount of time that elapses between placing a call on Park or on Hold and when that party is recalled.

LAST NUMBER REDIAL

If an attempt at an outside call is unsuccessful, (eg. a busy signal), simply press the single RDL Key for a one or more subsequent attempts.

LINE PICK-UP MODE

Pressing the PICK-UP Key and 0 to answer a ringing Line or common audible bell.

LINE QUEUING

Should a call be attempted when all outside lines are busy – users can elect to be called back and advised by voice announcement as soon as a line becomes available.

LINE / INTERCOM OFF-HOOK ASSIGNMENT

User control of station off hook preference for access to intercom or assigned Line Group dial tone.

DURATION DISPLAY

As a message is played, the LCD display shows its duration from the beginning of playback and counts down to message completion.

MESSAGE WAITING INDICATION

The unit will automatically activate the phone's message light and provide a real time display on LCD of type and number of messages.

MODEM (BUILT IN)

A built-in 14.4 kb Modem provides for system update and real time programming and debug.

MUTE

This fixed key mutes the speaker or handset microphone if pressed during a call.

NIGHT SERVICE

The system includes both automatic and manual control of Day/Night Mode.

PAGING

There are three built-in paging zones – and one (1) all-page via a fixed feature key.

PRIVATE LINE

Lines can be programmed to ring directly to a preset station, department or mailbox.

SERVICE OBSERVING

Stations designated to observe can be allowed to monitor conversations only on specified stations.

SYSTEM SPEED DIAL

Up to 100 names and associated numbers can be stored at a system wide level.

TOLL RESTRICTION

Based on Allow Local / LD combined with exception tables.

TECHNICAL SPECIFICATIONS

- SYSTEM TYPE:** PROPRIETARY EMBEDDED SYSTEM USING DSP TECHNOLOGY.
- CABINET:** WALL MOUNT 8.5" W x 11"H x 3" D (6 " D WITH EXPANSION CABINET).
- POWER:** 90-140 VOLTS AC, 50/60 Hz, 35 WATTS.
- CO LINE INTERFACE:** UP TO 16 ANALOG LOOP START PORTS WITH OPEN LOOP
DETECTION. MEETS FCC, UL, DOC, AND CSA
REQUIREMENTS.
ZAC: 600 OHMS.
REN: LESS THAN 1.0B.
10 KV SURGE T-GND, (T+R)-GND.
- STATION INTERFACE:** 4 WIRE ANALOG/DIGITAL INTERFACE TO UP TO 32 KEY TELEPHONES.
- VOICE STORAGE:** 17 HOURS AT 64 Kb/S SAMPLE RATE.
- STORAGE MEDIUM:** IDE DISK DRIVE CONTAINING PROPRIETARY ESI FORMAT, PROGRAMS,
CONFIGURATION, AND PROMPTS.
- DTMF DETECTION:** PASSES MITEL AND BELLCORE DTMF DETECTION TEST TAPES. -25
TO 0dBm, 40 MS / 40MS DETECT.
- DTMF GENERATION:** TOLERANCE +/-1%. HARMONIC ENERGY IS LESS THAN -16dB
BELOW THE FUNDAMENTAL FREQUENCY.
- CROSSTALK:** 200-3200 Hz: LESS THAN -80 dBm (REF 0dBm).
- RS232 INTERFACE:** 38.4 K B. 8 DATA BITS, 1 STOP BIT. FULL DUPLEX.
- MOH INTERFACE:** 8 OHM MINI CONNECTOR.
- BUILT-IN MODEM:** 14.4 KB.
- RFI:** FCC PART 15, CLASS A. SUSCEPTIBILITY: 30V/M .55-40 MHz, AM 1000
Hz.
- SAFETY:** UL1459 AND CSA 225.
- ENVIRONMENTAL:** OPERATING: 0 TO 50C, 0 TO 90% RH NON-CONDENSING.
STORAGE: -40 TO 65C.

NOTES:

HARDWARE INSTALLATION

IVX hardware configuration consists of the wall mounted System Cabinet (8.5" W x 11"H x 3" D) with an external wall mount transformer and the IVX Feature Phones. The cabinet houses the Main Board, slots for two 4 x 8 Port Cards, and the Memory Module. An expansion cabinet expands the system to 16 x 34.



MAIN BOARD

The main board combines leading-edge hardware components including a 68000 class Motorola processor and DSP structure along with proprietary operating system firmware. The board also provides: a standard RS 232 DB9 serial port for report output and on-site PC connection, a built-in 14.4K baud modem for remote programming/maintenance, and two analog ports.

MEMORY MODULE

A hard disk drive with proprietary formatting contains all system program and configuration data and pre-loaded voice prompts. IVX stores up to 30 hours of voice at 64Kb/s voice sampling.

PORT CARDS

Port cards provide for configurations in multiples of 4 loop start lines by 8 stations. Each port card has a standard female Amphenol connector for easy wiring to a standard 66 block.

FEATURE PHONES

The IVX Feature Phone is equipped with speaker phone, 32 character LCD display, and both fixed and programmable feature keys. Phones connect to the cabinet via standard 4 wire twisted pairs.

DSS/BLF CONSOLE

The DSS/BLF Console adds 48 additional Soft Feature Keys to a designated user's extension. The console requires a station port for connection and only one DSS/BLF Console can be installed per Port Card. Each console can be paired with any extension in the system.

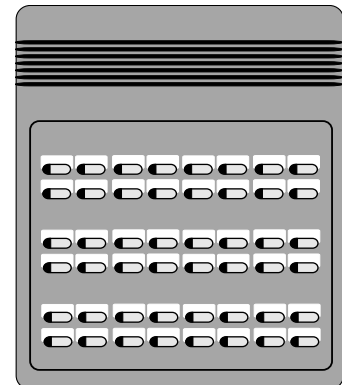

FOR YOUR SAFETY

This information complies with the requirements of Underwriter's Laboratories and UL Standard 1459.

When using this telephone equipment, always exercise basic safety precautions in order to minimize the risk of fire, electric shock or injury to persons. Before proceeding, please read the following:

The air-flow vents on the IVX case must be free of obstruction for proper cooling. Similarly, do not install the cabinet in areas of extreme heat or improper ventilation. Never insert objects of any kind through the ventilation slots on the system cabinet. Doing so may result in contact with dangerous voltages – or cause an electrical short capable of producing fire or shock.

Do not use liquids or aerosols to clean any IVX equipment; rather, use a cloth that is only slightly damp.

The IVX telephone/voice-mail system contains NO components that are serviceable by non-dealers or non-manufacturer technicians. **All service must be referred to the dealer for further handling.**

CAUTIONS

POWER SUPPLY

Always disconnect the power supply and telephone lines from the system cabinet before opening the case for service or component disassembly or replacement.

Heed all warnings and instructions in documentation or marked on the cabinet or peripheral equipment.

FUSE

Contact the factory prior to attempting to replace the fuse. The fuse is located on the mother-board directly next to the power jack marked with "F1".

**REGULATORY
REGISTRATION**

The CO Line telephone numbers, FCC registration number, and ringer equivalence of this equipment must be provided to the telephone company before installation.

FCC PART 15

This equipment has been tested and found to comply with the limits for a Class A digital device, pursuant to Part 15 of the FCC Rules. These limits are designed to provide reasonable protection against harmful interference when the equipment is operated in a commercial environment. This equipment generates, and uses, and can radiate radio frequency energy and, if not installed and used in accordance with the instruction manual, may cause harmful interference to radio communications. Operation of this equipment in which case the user will be required to correct the interference at his/her own expense.

FCC PART 68

Registration Number: 1T1USA-23770-MF-E.

RINGER EQUIVALENCE

REN 0.08

SITE LOCATION

As with most electronic equipment, the environmental considerations for this site need to observe good common sense. Avoid extreme temperatures and provide a dry, clean, and accessible area. **Do not place the equipment or station runs near high voltage electrical equipment or electrical lines susceptible to high voltage surges from air conditioner compressors, etc.**

Locate space in the telephone equipment room which will provide easy connection to: the 66 blocks (for the CO lines and stations) and 110VAC power. The location should be no further than 1,000 feet from the furthest station.

The system and supporting components should be mounted to a 1/2-inch or greater plywood backboard. A typical installation layout is shown below.

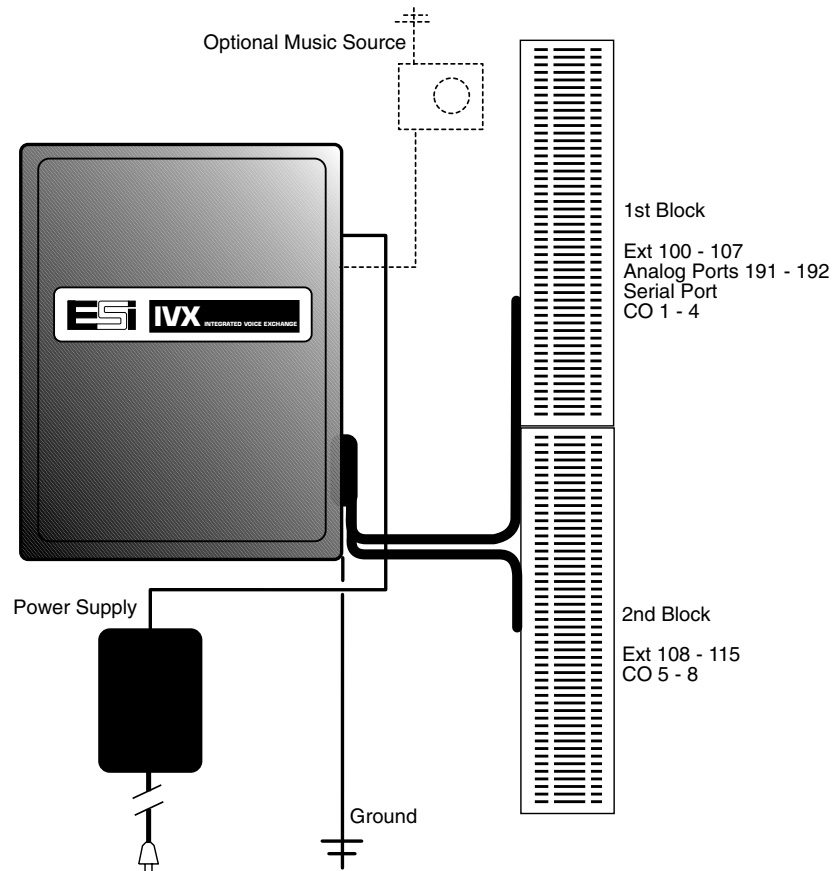

MOUNTING THE CABINET

Use three #8 Hex Head screws. Note the position of the three mounting holes in IVX. Also note that the top keyhole is slightly off-center to the left.

1) Screw in the top screw to the back board (at least 1/2 inch thick plywood) leaving about 1/8th inch clearance between the screw head and the plywood.

2) Hang the unit using the "keyhole" in the back of the case.

3) Level the unit and install the bottom two screws.

Attach the Power Transformer to the wall allowing sufficient length in both cords to reach the power connector on the upper right side of the cabinet and to reach a standard 110v outlet.

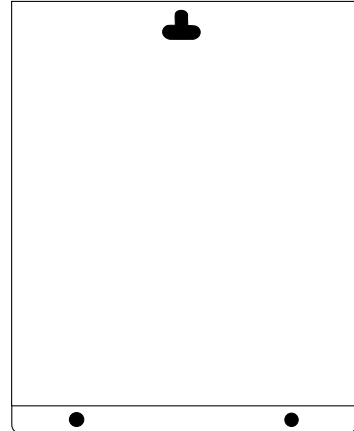

Do not connect power until all hardware connections have been made.

66 BLOCK WIRING DIAGRAM

Connect a standard male 50-pin Amphenol cable to each port card female connector located on the bottom-right side of the cabinet. The connector closest to the wall is the first card. Its 66 Block connects to the first 8 Stations, the 2 Analog Ports, the Optional Serial Data Port, and the first 4 CO Lines. The second Port Card connects to the second 8 Stations and the second 4 CO Lines. See Figure 1.

The Expansion Cabinet is required to add the third and fourth Port Cards.

FIGURE 1 66 BLOCK WIRING DIAGRAM

TERM	WIRE COLOR	1st Port Card			Additional Port Cards					
		SIGNAL	RJ11	PORT	SIGNAL	RJ11	2	3	4	
1	White-Blue	Tip	Green	Station 100 (Oper)	Tip	Green	108	116	124	
2	Blue-White	Ring	Red		Ring	Red				
3	White-Orange	Data+	Black		Data+	Black				
4	Orange-White	Data-	Yellow		Data-	Yellow				
5	White-Green	Tip	Green	Station 101	Tip	Green	109	117	125	
6	Green-White	Ring	Red		Ring	Red				
7	White-Brown	Data+	Black		Data+	Black				
8	Brown-White	Data-	Yellow		Data-	Yellow				
9	White-Slate	Tip	Green	Station 102	Tip	Green	110	118	126	
10	Slate-White	Ring	Red		Ring	Red				
11	Red-Blue	Data+	Black		Data+	Black				
12	Blue-Red	Data-	Yellow		Data-	Yellow				
13	Red-Orange	Tip	Green	Station 103	Tip	Green	111	119	127	
14	Orange-Red	Ring	Red		Ring	Red				
15	Red-Green	Data+	Black		Data+	Black				
16	Green-Red	Data-	Yellow		Data-	Yellow				
17	Red-Brown	Tip	Green	Station 104	Tip	Green	112	120	128	
18	Brown-Red	Ring	Red		Ring	Red				
19	Red-Slate	Data+	Black		Data+	Black				
20	Slate-Red	Data-	Yellow		Data-	Yellow				
21	Black-Blue	Tip	Green	Station 105	Tip	Green	113	121	129	
22	Blue-Black	Ring	Red		Ring	Red				
23	Black-Orange	Data+	Black		Data+	Black				
24	Orange-Black	Data-	Yellow		Data-	Yellow				
25	Black-Green	Tip	Green	Station 106	Tip	Green	114	122	130	
26	Green-Black	Ring	Red		Ring	Red				
27	Black-Brown	Data+	Black		Data+	Black				
28	Brown-Black	Data-	Yellow		Data-	Yellow				
29	Black-Slate	Tip	Green	Station 107	Tip	Green	115	123	131	
30	Slate-Black	Ring	Red		Ring	Red				
31	Yellow-Blue	Data+	Black		Data+	Black				
32	Blue-Yellow	Data-	Yellow		Data-	Yellow				
33	Yellow-Orange	Tip	Green	Analog Port 191						
34	Orange-Yellow	Ring	Red							
35	Yellow-Green	Tip	Green		Analog Port 192					
36	Green-Yellow	Ring	Red							
37	Yellow-Brown	CTS		Serial Port						
38	Brown-Yellow	RTS								
39	Yellow-Slate	TXD								
40	Slate-Yellow	RXD								
41	Violet-Blue	GND								
42	Blue-Violet	GND								
							CO			
43	Violet-Orange	Tip	Green	CO 1	Tip	Green	5	9	13	
44	Orange-Violet	Ring	Red		Ring	Red				
45	Violet-Green	Tip	Green	CO 2	Tip	Green	6	10	14	
46	Green-Violet	Ring	Red		Ring	Red				
47	Violet-Brown	Tip	Green	CO 3	Tip	Green	7	11	15	
48	Brown-Violet	Ring	Red		Ring	Red				
49	Violet-Slate	Tip	Green	CO 4	Tip	Green	8	12	16	
50	Slate-Violet	Ring	Red		Ring	Red				

ELECTRICAL REQUIREMENTS

GROUNDING INSTRUCTIONS

IVX grounding (supplemental ground) is as follows:

- The conductor wires can be no smaller than the ungrounded branch-circuit supply conductors (usually 16 gauge or higher).
- Acceptable wire: bare or covered with green or green and yellow striped jacket.
- Conductors (and power receptacles) shall connect to earth ground at the service equipment (usually a cold water pipe or copper ground rod).
- The supplemental ground must: be used regardless of power cord ground, be connected to the ground lug on the bottom of the IVX cabinet, and retain ground connection when IVX power supply module is unplugged.

Note: IVX Lines are protected against a 10Kv surge only if the earth ground procedures described above are followed.

POWER

The base unit requires a single 110v AC outlet – **Use only the Class-2 power supply module provided with the system.** The expansion cabinet requires no additional AC power. A clean, isolated power source in conjunction with a UPS is strongly recommended. IVX maximum power consumption is 50 watts.

Note: If power is lost, the system will drop all connections. When power is restored, the system will restart and resume normal operation in approximately 60 seconds retaining its full programming and clock setting.

UPS

For system protection and to maintain uninterrupted operation, an Uninterruptible Power Supply (UPS) is strongly recommended. A UPS rated for 200VA will provide approximately three hours of uninterrupted service for a fully loaded (16 X 34) IVX. Every 50VA of capacity added to the UPS will yield approximately one additional hour of backup.

MOH PORT

If music on hold is to be supplied from an external source, connect the source to the MOH connector or the upper right side of the cabinet via a standard 1/8" monophonic mini jack. Custom messages-on-hold can be downloaded and stored to disk from any standard cassette player via this port.

SERIAL PORT

A standard serial printer or laptop PC may be connected to the DB9 Serial connector on the side of the cabinet or connected through punch down on the 66 Block for locating the PC outside of the equipment room. A standard shielded serial cable DB9 to DB25 should be used (Radio Shack #26-117 or equivalent) to connect to a laptop.

The maximum distance from the cabinet is 100 ft.

The output from the serial port is: programmable from 300 bd to 38.4 KB, 8 data bits, 1 stop bit, and no parity. The pinout is: Data Transmit – Pin 2, Receive – Pin 3, and Ground – Pin 5.

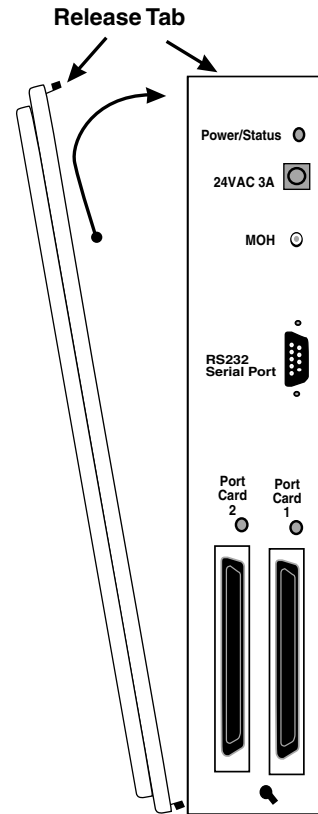

CO LINE CONNECTION

IVX's advanced CO Line circuitry provides for Open Loop detection and built-in Caller ID interface.

These features require more precise CO Line conditioning than was originally established for mechanical switches by the Bell System.

Note: CO Line Tip & Ring polarity must be observed.

To verify line polarity, use a volt meter set for DC volts. Measure the CO Lines when the lines are idle with the bridge clips removed.

1. Connect the black (negative) lead of a meter to the ground source used to ground IVX.
2. Connect the Red Lead to Tip (the first lead of the pair). Less than 2 volts should be read.

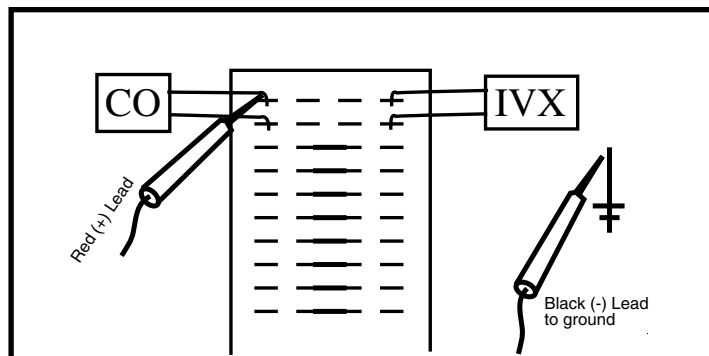

3. Verify that the second lead is Ring: -40 to -53 volts.
4. Repeat the steps above for all CO Lines

The CO Lines are connected via the last 4 pairs on each Port Card's 66 Block. See Figure 1. Observe correct order of connection to preserve proper rotary hunting of the CO Lines.

STATION CONNECTION

Each station is connected to the system through the first 16 pairs of each 66 block. The stations are connected using 2 pairs per station. The first pair is Tip & Ring, and the second pair is Data.

Note: The order for the Data pair must be observed. If reversed, a single character will appear on the phones display indicating the fault.

The station runs can be up to 1,000 ft. Only one phone can be connected per station port. Each port position is prenumbered and fixed as indicated in the 66 Block wiring diagram (Figure 1).

DSS/BLF CONSOLE CONNECTION

The DSS/BLF Console is connected to a standard Feature Phone port as described above. Up to 4 consoles can be installed in a fully configured system. **Only one console can be installed on a port card.** Each console is paired with a station when the console is configured as part of extension programming (Function 3).

ANALOG PORT CONNECTIONS

The system provides two dedicated analog ports for: FAX, Modem, Common Ringer, Door Phone, Overhead Paging, or restricted 2500 phone. A single analog Tip & Ring pair is connected through the first 66 block. Terminal connections are 33 & 34 for the first analog port and 35 & 36 for the second.

Note: These ports are not designed for outside use or for any use other than as stated above.

MEMORY MODULE

Note: The Memory Module is formatted with a proprietary format– do not attempt to install a non-ESI drive.

Adding or replacing the Memory Module will require that the system be taken out of service. If the Memory Module must be replaced, all configuration data and customer recordings will be lost.

Contact the factory for a replacement Memory Module and detailed instructions for its installation.

LED FUNCTION

The unit's various LEDs are designed to provide visual feedback as follows:

POWER LED

The Power LED is located on the top-right side of the cabinet and is illuminated when power is being applied to the system. The LED blinks periodically to indicate that the main processor is operational.

PORT LEDs

The Port LEDs are located above their respective Amphenol connectors on the right side of the cabinet. Each LED is illuminated when CO traffic is currently being processed by its card.

Caution: Disconnecting an Amphenol connector when its respective LED is lit will cause one or more outside calls to be disconnected.

Note: Upon power-up, approximately 30 seconds are required for the system to configure. The Power and Port LEDs will blink three times to indicate that the power up sequence has been completed.

MEMORY TRANSFER LED

This LED is located inside the cabinet on the top center of the main board and flashes as data is transferred to and from the Memory Module.

PORT CARD INSTALLATION

Adding or replacing Port Cards will require the system to be taken out of service.

- 1) Wear a grounding strap or be sure to touch the metal case frequently and avoid unnecessary movement while handling the circuit boards.
- 2) Unplug the power supply to IVX.
- 3) Remove the case lid by removing the two phillips screws.

The two Port Cards are located in the bottom half of the cabinet— one behind the other. They are ribbon cabled to the main board from a connector in the upper left corner of the card. The second Port Card (the uppermost card) will need to be removed if access to the first card is required.

4) Removal of Port Cards— Disconnect the Amphenol connector from the card. Carefully unplug the ribbon cable that runs to the main board. Remove the 6 phillips screws and carefully remove the card from the cabinet.

5) Installation of Port Cards— observe the locations and relative positions of the card over the stand-offs. Install the 6 phillips screws, connect the ribbon cable to the correct connector on the main board and connect the Amphenol cable.

6) Power up IVX. The Power and Port Card LEDs will blink three times when the power up sequence is completed.

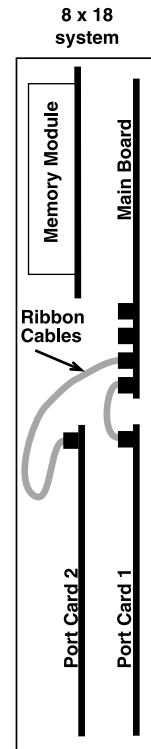

EXPANSION CABINET

The Expansion Cabinet provides for the expansion of the system from its initial configuration of 8 x 18 to 16 x 34. It houses up to two Port Cards for connection to the Main Board via ribbon cable through the opening in the back of the Expansion Cabinet.

THE INSTALLATION STEPS ARE AS FOLLOWS:

1) Wear a grounding strap or be sure to touch the metal case frequently and avoid unnecessary movement while handling the circuit boards.

2) Unplug the power supply to IVX.

3) Remove the base cabinet lid by removing the release tab at the top of the cabinet and rock back the lid to pull free from the bottom of the cabinet.

4) Install the expansion cabinet on the front of the Base Cabinet using the slots at the top of the cabinet originally used to hold the Base Cabinet's lid.

5) Lock the Expansion Cabinet to the Base Cabinet by snapping the top in place.

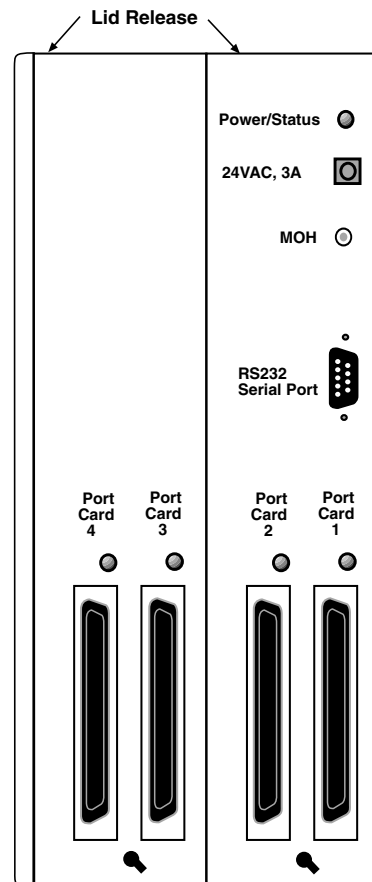

Expanded Cabinet

6) Connect the grounding strap from the Expansion Cabinet's grounding lug (located on the bottom of the cabinet) to the Base Cabinet's grounding lug. Follow the grounding procedures as described earlier for grounding the Base Cabinet.

7) Through the large opening in the back of the Expansion Cabinet, connect the ribbon cable(s) from the Port Card(s) to the correct connector on the main board of the Base Cabinet.

8) Re-install the original lid from the Base Cabinet on the face of the Expansion Cabinet and attach with the two phillips screws.

9) Follow the instructions for Ports Card wiring as described earlier.

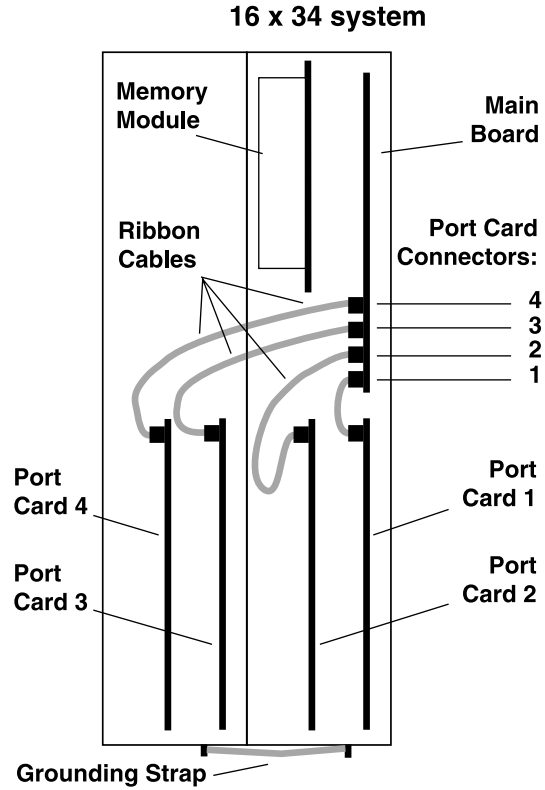

TUTORIAL

This tutorial provides general programming examples designed to provide an overall understanding of IVX and its programming technique. Study it carefully before programming. It will be helpful to refer the following items frequently while using this tutorial:

- System Numbering Plan (Section 4)
- System Programming Overview (Section 4)
- Programming Worksheet



FUNCTION 1 SYSTEM PARAMETERS

Functions 11 through 16 set the system-wide parameters such as: the clock, passwords, ringback/recall settings, flashhook duration, etc.



FUNCTION 2 CO LINE PROGRAMMING

The CO Lines can be programmed individually or in groups of lines. Inbound answering assignment is the most flexible of any phone system available. Individual lines can have several delayed ringing destinations based on the number of unanswered rings.

The default setting is for all calls to go to the Auto Attendant on the first ring. The destination can be changed to an Extension, Department, or Mailbox.

The CO Lines can also be programmed for different operation in Day Mode and Night Mode since the answering requirements may be different for after hours.

Lines are also assigned to a CO Line Group (9, 8, or 7) to provide PBX (pooled) access.



PRIMARY ANSWER AT THE OPERATOR

CUSTOMER REQUIREMENT

A company wants all of its calls answered by the operator (X100) except by the Auto Attendant if not answered after excessive ringing.

PROGRAMMING TECHNIQUE

In the example, the Line is programmed to ring at the operator's extension until the 9th ring and then be answered by the Auto Attendant (ID1). The worksheet example is:

<u>CO</u>	<u>OUT</u>	<u>Ring 1</u>	<u>Ring 3</u>	<u>Ring 5</u>	<u>Ring 9</u>
1	9	100	100	100	ID1



PRIMARY ANSWER AT THE AUTO ATTENDANT

CUSTOMER REQUIREMENT

A company wants all of its calls answered by the Auto Attendant.

PROGRAMMING TECHNIQUE

In the example, Line 1 will be answered immediately by the Auto Attendant (ID1 is the Main Greeting). This is default for both Day and Night Mode.

Note: See Auto Attendant Programming Techniques for examples of how to route the caller once answered by the Auto Attendant. The worksheet example is:

<u>CO</u>	<u>OUT</u>	<u>Ring 1</u>	<u>Ring 3</u>	<u>Ring 5</u>	<u>Ring 9</u>
1	9	ID1			

PRIMARY ANSWER AT THE OPERATOR WITH OVERFLOW TO OTHERS

CUSTOMER REQUIREMENT

A company wants all of its calls answered by the operator (X100) when available, add other extensions if not answered promptly and finally answered by the Auto Attendant if not answered after excessive ringing.

PROGRAMMING TECHNIQUE

In the example, Line 1 will ring at the operator's extension on the first ring. On the 3rd ring extension 112 and 113 are added. On the 5th ring, the operator's station is dropped from ringing. On the 9th ring the call will be answered by the Auto Attendant. The worksheet example is:

<u>CO</u>	<u>OUT</u>	<u>Ring 1</u>	<u>Ring 3</u>	<u>Ring 5</u>	<u>Ring 9</u>
1	9	100	100 112 113	112 113	ID1

NIGHT ANSWER TO A GENERAL DELIVERY MAILBOX

CUSTOMER REQUIREMENT

A company wants all of its after hours calls answered with the caller given the choice to leave a message.

PROGRAMMING TECHNIQUE

In the example, during Night Mode, Line 1 will be answered immediately by MB301 (a Guest Mailbox set up for general delivery). The Personal Greeting recorded might be: *"Hello, thank you for calling ABC Company. Our offices are closed. Our normal business hours are 8 to 5 Monday through Friday. Please leave a message at the tone and your call will be returned when we resume normal business hours."* The worksheet example is:

NIGHT MODE

<u>CO</u>	<u>OUT</u>	<u>Ring 1</u>	<u>Ring 3</u>	<u>Ring 5</u>	<u>Ring 9</u>
1	9	MB301			

 **TO PROVIDE PRIVATE LINE CAPABILITY**

CUSTOMER REQUIREMENT

A company president (X115) wants a private line but also wants his secretary to handle his overflow.

PROGRAMMING TECHNIQUE

In the programming example below, Line 5 is set as Outbound Group 7 and to ring at Extension 115 on the first ring. If not answered by the 3rd ring, add ringing to the secretary (114), and if not answered by the 5th ring to go to extension 115's mailbox. Assign Line Group 7 only to X115 to make Line 5 private. The worksheet example is:

<u>CO</u>	<u>OUT</u>	<u>Ring 1</u>	<u>Ring 3</u>	<u>Ring 5</u>	<u>Ring 9</u>
5	7	115	115 114	MB115	

 **SELECTIVE ANSWER BY THE OPERATOR AND AUTO ATTENDANT**

CUSTOMER REQUIREMENT

The company wants customer calls to be answered by the operator but have vendors, employees and spouses call a different CO pilot number to be routed by the Auto Attendant.

PROGRAMMING TECHNIQUE

In the example, Lines 1 to 3 will ring at the operator's extension, while lines 4 & 5 are answered immediately by the Auto Attendant. Notice that the Auto Attendant will answer Lines 1 to 3 only after 9 rings. The worksheet example is:

<u>CO</u>	<u>OUT</u>	<u>Ring 1</u>	<u>Ring 3</u>	<u>Ring 5</u>	<u>Ring 9</u>
1	9	0	0	0	ID1
2	9	0	0	0	ID1
3	9	0	0	0	ID1
4	9	ID1			
5	9	ID1			

TENANT SERVICES
CUSTOMER REQUIREMENT

Two companies share an office. They each wish to have their phones handled differently. ABC Realtors wishes live answer at the sales-rep-of-the-day desk (with overflow to the Auto Attendant). ABC Insurance wishes to be answered by the Auto Attendant full time. Each wants their own Main Greeting.

PROGRAMMING TECHNIQUE

In the example, Lines 1 to 3 will ring at the sales-rep-of-the day desk (105) and overflow to ABC Realtors' Main Greeting (ID1). Lines 4 to 6 are answered immediately by ABC Insurance's Main Greeting (ID2).

Line Group 9 would be assigned to the personnel for ABC Realtors while Line Group 8 assigned to ABC Insurance employees (If all employees work for both, they could all be assigned to the same Line Group).

Note: Each ID will also have a different Night Main Greeting as well. (See Auto Attendant Programming Techniques for further ideas on using ID2.) The operator station (100) must serve as operator for both companies and the Automatic Day/Night table also applies to both companies. The worksheet example is:

<u>CO</u>	<u>OUT</u>	<u>Ring 1</u>	<u>Ring 3</u>	<u>Ring 5</u>	<u>Ring 9</u>
1	9	104	104	ID1	
2	9	104	104	ID1	
3	9	104	104	ID1	
4	8	ID2			
5	8	ID2			
6	8	ID2			



TOLL RESTRICTION (FUNCTION 22)

CUSTOMER REQUIREMENT

A company with 10 employees wants 5 users to be have no toll restrictions, 5 to be able to make only non-toll calls and a lobby phone that can only intercom to other stations. They also want all employees to be able to call their outside sales rep at 212 565-9898.

PROGRAMMING TECHNIQUE

Since Toll Calls by default are allowed to all extensions, the Installer when programming Extension Feature Authorization (Function 32), would change the Tolls feature to NO for the 5 users that are only to make non-toll calls. In Function 22 (Toll Restriction Tables) the Installer would input 12125659898 into the Allow Exception Table permitting all users to call that number. In Function 31 (Extension Definition and Routing), the lobby extension would have no Line Group assigned thus denying it access to any outside line.



FUNCTION 31 EXTENSION DEFINITION AND ROUTING



STATION PROGRAMMING

CUSTOMER REQUIREMENT

A company wants Jane to be able to access Line Group 9 and have her night calls forwarded to the night clerk at X105 and be in Page Zones 1 and 2. They want Roger's call handling to be station default.

PROGRAMMING TECHNIQUE

In the example, note how each station is programmed. The worksheet example is:

<u>EXT</u>	<u>NAME</u>	<u>CO</u>	<u>CF DAY</u>	<u>CF NIGHT</u>	<u>PGZN</u>
100	JANE	9	MB100	X105	1, 2
101	ROGER	9	MB101	MB101	

**FUNCTION 32 EXTENSION FEATURE AUTHORIZATION****STATION CLASS OF SERVICE PROGRAMMING****CUSTOMER REQUIREMENT**

A company wants the employees to have all features allowed, a lobby phone that can only make intercom or local calls and cannot be reached inadvertently by someone dialing the extension number by accident. They also want a conference room phone that can record conversations, make toll calls and be able to be placed in DND.

PROGRAMMING TECHNIQUE

In the example, note how each feature is allowed or denied. The worksheet example is:

<u>EXT</u>	<u>NAME</u>	<u>CAMP</u>	<u>DND</u>	<u>AA BLOCK</u>	<u>REC</u>	<u>S/OB</u>	<u>TOLL</u>
100	JANE	Y	Y	N	Y	N	Y
101	ROGER	Y	Y	N	Y	N	Y
102	SALLY	Y	Y	N	Y	N	Y
110	LOBBY	N	N	Y	N	N	N
111	CONF RM	N	Y	Y	Y	N	Y

**FUNCTION 33 DEPARTMENT PROGRAMMING**

Departments consist of a pilot number (range 200 to 209) and one or more extensions assigned. The Department can distribute calls to its members by calling them: All at the same time, in the order listed, in Uniform Call Distribution, in Automatic Call Distribution. Additionally a Department can be set to serve as a Pick-Up Group (without receiving calls).

Note: The Department pilot number should be programmed as a Soft Feature Key for easy transfer. A Soft Feature Key must be programmed in order to pick up a call ringing in a Pick-Up Department.



ALL STATIONS AT THE SAME TIME

CUSTOMER REQUIREMENT

A company has three admin clerks each of which is able to handle any type of call.

PROGRAMMING TECHNIQUE

In the example, to get the most immediate service the calls are set to ring all three clerk's extensions at the same time. The worksheet example is:

<u>EXT</u>	<u>TYPE</u>	<u>NAME</u>	<u>CF DAY</u>	<u>CF NIGHT</u>	<u>PGZN</u>
200	ALL	ADMIN	MB102	MB102	
EXT List: 102 104 112					



STATIONS RUNG IN THE ORDER LISTED

CUSTOMER REQUIREMENT

A company has 4 sales reps of varying capabilities. They want the best rep to always get the next call and if busy, the next best rep will get the next inbound call (and so on).

PROGRAMMING TECHNIQUE

The reps' extension numbers would be listed in the Department with the best reps number first, advancing to the rep with the least capability. Additionally, the number one rep (ext 106) will have all calls that are busy or no answer to the entire Department sent to his mailbox. The worksheet example is:

<u>EXT</u>	<u>TYPE</u>	<u>NAME</u>	<u>CF DAY</u>	<u>CF NIGHT</u>	<u>PGZN</u>
200	Order	Sales	MB106	MB106	
EXT List: 106 103 105 113					

 UCD
CUSTOMER REQUIREMENT

A company wants the 4 sales reps to have the calls evenly distributed to the reps in a round robin fashion. If they are all busy or no answer, the calls will be call forwarded to the sales manager's mailbox. The worksheet example is:

<u>EXT</u>	<u>TYPE</u>	<u>NAME</u>	<u>CF DAY</u>	<u>CF NIGHT</u>	<u>PGZN</u>
200	UCD	Sales	MB108	MB108	
EXT List: 106 103 105 113					

 ACD
CUSTOMER REQUIREMENT

A company wants the 4 sales reps to have the calls evenly distributed to them in an ACD fashion (new calls sent to the longest idle agent and if all busy, calls held for the first available rep). If all available reps are busy the caller will be held (and played periodic announcements) until a rep becomes available. When the exit timer has been reached (the longest that you want a caller to hold) the caller will then be transferred to the call forward destination. The worksheet example is:

<u>EXT</u>	<u>TYPE</u>	<u>NAME</u>	<u>CF DAY</u>	<u>CF NIGHT</u>	<u>PGZN</u>
200	ACD	Sales	MB106	MB106	
EXT List: 106 103 105 113					

Note: Blind transfer of a call to the Department when its programmed Station Key is unlit will transfer to the longest idle agent. If all agents are busy, the call can still be transferred by pressing the lit Station Key. The transferred caller will hear the "all agents are busy prompt" and be placed in Queue along with any other callers who may be in Queue.

**PICK-UP GROUP****CUSTOMER REQUIREMENT**

The members of the accounting team want to be able to easily answer ringing calls for anyone in the Department even though each will only receive calls directed to their individual extensions.

PROGRAMMING TECHNIQUE

If placed in a pick-up group, then any one of the team can answer any of the ringing stations by pressing the Pick-Up key and then pressing the Soft Feature key programmed with the Department's pilot number.

Note: There is no mailbox or call forward for a pick-up group. Calls will be call forwarded per the individual extension called.

THE WORKSHEET EXAMPLE IS:

<u>EXT</u>	<u>TYPE</u>	<u>NAME</u>	<u>CF DAY</u>	<u>CF NIGHT</u>	<u>PGZN</u>
200	UCD	Sales			
EXT List: 102 104 112					

**FUNCTION 34 ANALOG EXTENSION PROGRAMMING****HEAVY FAX USAGE****CUSTOMER REQUIREMENT**

A company wants to be able to have a dedicated FAX line for automatic incoming FAX as well as the ability to have a caller transferred to the FAX even if he has called in on a regular line.

PROGRAMMING TECHNIQUE

The Installer would install the dedicated FAX line as one of the system CO Lines (not in rotary with the other lines) but program it to be answered by Extension 191 on the 1st Ring (see Line Programming examples) and to be in Line Group 7. Extension 191 would be programmed as a FAX extension with access Line Group 7. Busy No answer calls would be disconnected. Additionally, X191 should be programmed as a Station key at

the stations that will transfer to FAX. Also, the system will automatically transfer to X191 any call that generates a FAX tone when first answered. The worksheet example is:

<u>EXT</u>	<u>TYPE</u>	<u>RING DN</u>	<u>CF DAY</u>	<u>CF NIGHT</u>	<u>TOLL</u>
191	FAX	7	9999	9999	Y



OVERHEAD PAGING AND DOOR PHONE

CUSTOMER REQUIREMENT

A company wants to have access to overhead paging and wants a lobby phone that will only call the operator when it is taken off hook.

PROGRAMMING TECHNIQUE

Analog Extension 191 would be programmed as Page which will allow the station to be connected to a commercial paging unit and transmit DTMF tones to the unit (if required for Zone Paging). A DSS Key could be programmed for direct access to X191. Analog Extension 192 would be programmed as DOOR with Ring Down set for extension 100.

Note: Many overhead paging units are designed to be connected to a CO Line port of the system and accessed by pressing a Line Key.

Note: PAGE does not require a Ring Down setting and neither requires a Call Forwarding destination. The worksheet example is:

<u>EXT</u>	<u>TYPE</u>	<u>RING DN</u>	<u>CF DAY</u>	<u>CF NIGHT</u>	<u>TOLL</u>
191	PAGE				
192	DOOR	100			



FUNCTION 41 AUTO ATTENDANT PROGRAMMING

IVX's Auto Attendant follows a branch concept whereby the caller is routed through a series of branches— ultimately to the extension he wishes to reach. He moves from branch to branch by selecting a number or name presented as choices.

BRANCH TYPES

There are three types of branches that can be used to create limitless routing possibilities:

1. A MENU BRANCH

This branch includes a prompt that instructs the caller to make single digit selections from the choices presented. Whenever a Menu Branch is created, its sub-branches must also be created.

Example: If Branch ID 14 is a Menu Branch with 3 choices presented to the caller in its prompt such as “ For Mac Support press 1, for DOS Support press 2, or to return to the Main Greeting press 3.”, sub-branches (what will occur if the caller chooses 1, 2, or 3) 141, 142, and 143 must be created and programmed.

2. A GoTo BRANCH

This type branch actually connects the caller to his desired destination. It can have as its destination an Extension, Department, Mailbox, Branch ID, or Outdial (off-premise) number.

Example: In a Menu Branch : “For widget sales press 1, for gadget sales press 2, or to return to the Main Greeting press 3.”, the three sub-branches would all be GoTo Branches with the first destination (ID11) going to the widget sales Department, the second (ID12) to the gadget Department, and the third sub-branch would go to ID1 (Main Greeting) as its programmed destination.

3. A DIRECTORY BRANCH

The Directory Branch allows the caller to reach a user by selecting his or her name from a directory. The list of names can be presented to the caller in one of two ways: all of names recorded; or sorted by asking the caller to input the first letter of the first or last name.

BRANCH COMPONENTS

In these examples presented below, each box represents a branch with the following associated information:

BRANCH ID

A numeric designator used to access the branch for programming and which indicates its location and relationship to the other branches.

BRANCH NAME

Used to help identify the branch in reports or later programming changes.

DESTINATION

Where the branch leads:

<u>Branch Type</u>	<u>Possible Destinations</u>
Menu	Sub-branches
GoTo	Extension, Department, Mailbox, or Outdial Location
Directory	Names

In a Menu Branch the destinations are always sub-branches. In a GoTo Branch the destination is an extension number, another branch ID, a mailbox, or a “string” of digits or commands for dialing outside of the system. In a Directory Branch the destination is a list of names which are then translated by the system to extension numbers and called.



BASIC AUTO ATTENDANT

CUSTOMER REQUIREMENT

A company wants to provide the caller with options to reach sales (3 extensions), service (4 extensions), admin (1 extension), and a company directory (by all names).

PROGRAMMING TECHNIQUE

As part of extension programming, the Installer would have created a sales Department (201) with the 4 extensions and a service Department (202) with the 3 extensions. The worksheet example is:

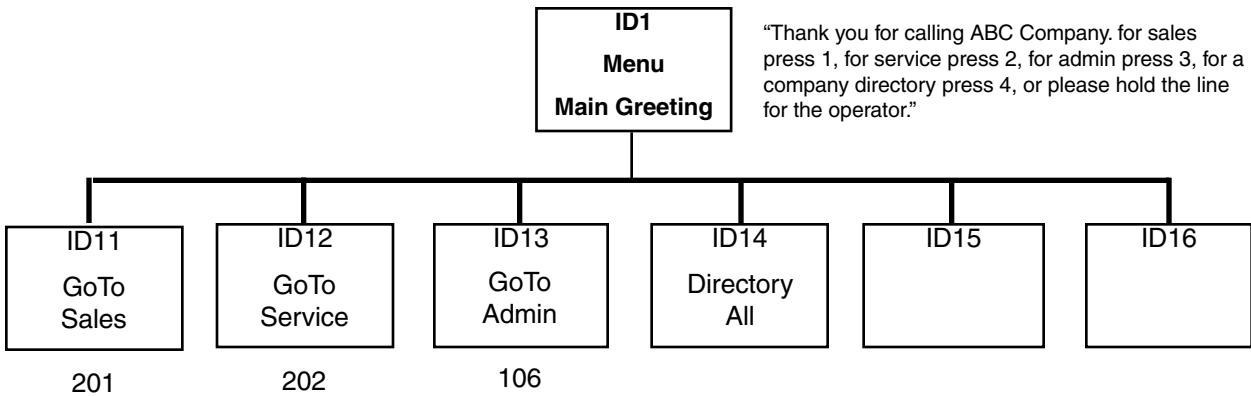

 **AUTO ATTENDANT WITH SUB-MENUS**

CUSTOMER REQUIREMENT

In the above example, the customer wants to have sales broken into widget and gadget calls, and admin calls directed to either the accounts payable clerk (104), or the accounts receivable clerk (106).

PROGRAMMING TECHNIQUE

This could have been accomplished by listing all of these choices in the Main Greeting, but it will be better to break up the choices presented to the caller. In this case the Installer would create two sales Departments (200 and 201) with the appropriate sales extensions in each. The worksheet example is:

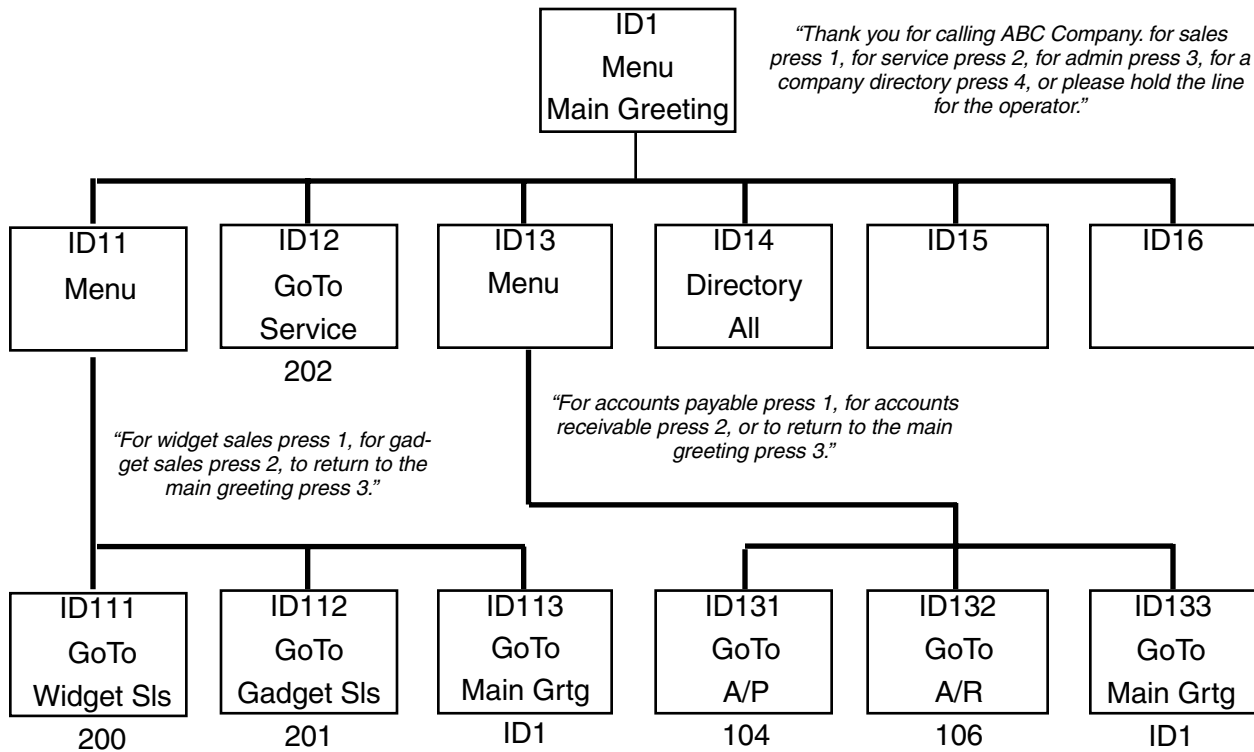



NIGHT MODE ROUTING

CUSTOMER REQUIREMENT

The company in the first example wants callers during after hours to be able to reach the Tech on call if they have an emergency or to leave a message to be returned the next day if not an emergency.

PROGRAMMING TECHNIQUE

The branch structure would be identical to the first example with the addition of branch IDs 15 and 16. These selections would be presented only in the Night Main Greeting. ID 15 would be programmed to go to a Cascade Paging Mailbox (920) and ID 16 would go to the operator's mailbox (100). The worksheet example is:

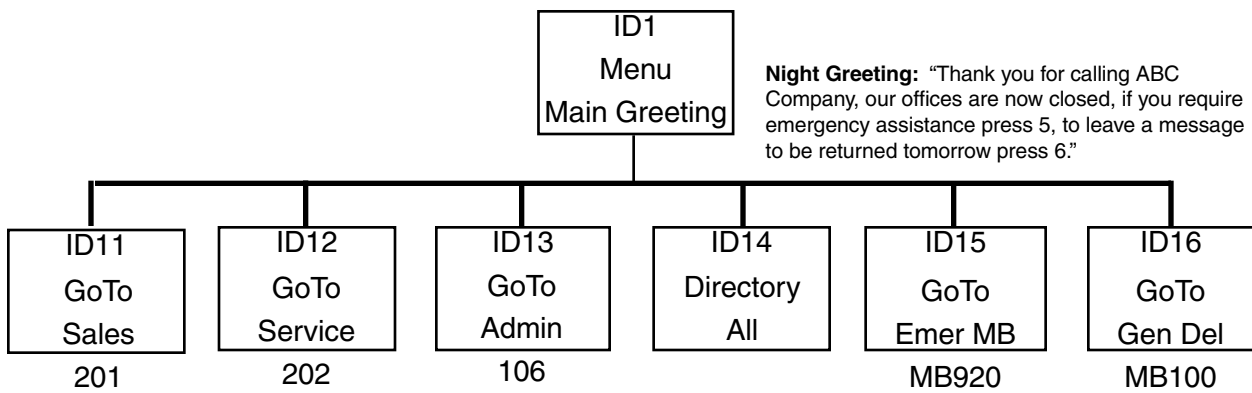



CREATING A DIRECTORY

CUSTOMER REQUIREMENT

A company with 21 employees wants to provide a directory as part of its Main Greeting.

PROGRAMMING TECHNIQUE

Since 21 employees is probably too many to present all to a caller, a Directory Branch is created as part of Auto Attendant programming and set to be played alphabetically. In the Record Directory Names programming (Function 62), record the user's names and the associated letter on the dial pad corresponding to the first letter of either his first or last name. The worksheet example is:

<u>EXT</u>	<u>NAME</u>	<u>KEY</u>	<u>EXT</u>	<u>NAME</u>	<u>KEY</u>
100	George Smith	4	116	Paul Thones	7
101	Phil Jones	7	117	Jane Doe	5

Tip: If, as example, the company president only wants callers who knows his extension number to be able to reach him— simply don't include his name in the directory. If he does not want any calls at all to reach him through the Auto Attendant, set his extension for Auto Attendant Block as part of Extension Programming. Use this technique to exclude other extensions (such as a lobby phone, modem extension, etc.) from being inadvertently reached through the Auto Attendant.

✉ **FUNCTION 5 VOICEMAIL PROGRAMMING**

✉ **INFORMATION ONLY MAILBOX (FUNCTION 54)**

CUSTOMER REQUIREMENT

A small real estate company wants to publish a list of houses with calling instructions to get additional information. They want the caller to be played the information and transferred to the operator during the daytime and played the information and disconnected if during the night time.

PROGRAMMING TECHNIQUE

Those interested can call the main number and enter the corresponding extension number at the Main Greeting. A description of each house is recorded as the “personal greeting” for the corresponding Info Mailbox . Mailboxes 300 to 599 can be used. The worksheet example is:

<u>EXT</u>	<u>TYPE</u>	<u>NAME</u>	<u>CF DAY</u>	<u>CF NIGHT</u>
300	INFO	HOUSE 6044	100	9999

✉ **GUEST MAILBOX (FUNCTION 54)**

CUSTOMER REQUIREMENT

A company has an outside sales rep and wants him to be able to receive messages at the home office.

PROGRAMMING TECHNIQUE

In the example below, Thomas has been given extension/mailbox number 321. Any outside caller can dial 321 at the Main Greeting or select his name from the directory and be transferred to his mailbox. Additionally, 321 could be programmed as a Station Key on anyone’s station that might need to frequently transfer live callers to his mailbox. Thomas could have his calls placed in some else’s mailbox, or have someone else’s message light activated to pick up his messages to relay to him, or he could have the system page his pager to notify him of new messages (see Paging in this section). The worksheet example is:

<u>EXT</u>	<u>TYPE</u>	<u>NAME</u>	<u>CF DAY</u>	<u>CF NIGHT</u>
321	GUEST	THOMAS		

✉ **GROUP MAILBOX FOR ONE OWNER (FUNCTION 53)**

CUSTOMER REQUIREMENT

The East Coast Regional Sales manager wants to be able to periodically leave the same message for his five sales reps.

PROGRAMMING TECHNIQUE

The Administrator assigns him a Group Mailbox number in the range 501 to 516. The Installer, Administrator or user can program the list of member's mailbox numbers. In this case, the manager would not give out the Group Mailbox number 501 or password since he will be the only one leaving group messages. The worksheet example is:

<u>MB</u>	<u>MEMBERS</u>
500	All (Broadcast)
501	114, 115, 108, 109, 111

✉ **GROUP MAILBOX FOR MULTIPLE OWNERS (FUNCTION 54)**

CUSTOMER REQUIREMENT

The East Coast Regional Sales manager in the above example also wants to be able to have his five sales reps leave sales tips for each other.

PROGRAMMING TECHNIQUE

The Administrator should assign him an additional Group Mailbox number. In this case, the manager would give out the Group Mailbox number 502 to his reps and set the password to "0" so that anyone calling 502 could leave a message without having to enter a password. He also added his extension number 110 to the list. The worksheet example is:

<u>MB</u>	<u>MEMBERS</u>
500	All (Broadcast)
501	114, 115, 108, 109, 111
502	114, 115, 108, 109, 111, 110

 **EXTERNAL PAGING PROGRAMMING**

Various techniques can be used to notify a user through commercial pagers that a new message has been taken in his mailbox. The system will dial the paging number programmed by the user as part of his station programming. Additionally, 10 Cascade Paging Mailboxes are available for multiple notification requirements (see Function 56 for details).

 **INDIVIDUAL USER PAGING NOTIFICATION (FUNCTION 55)****CUSTOMER REQUIREMENT**

A user wishes to be notified via his pager whenever a new message has been left in his mailbox.

PROGRAMMING TECHNIQUE

A part of his station programming, he will input the phone number required to activate his pager. His pager will be activated whenever he receives his first new message and be reminded with additional periodic pages until the new message has been picked up. The system will dial the paging number programmed by the user and automatically pause, dial the mailbox number, # and go on hook. This will show his mailbox number in his pager display to alert him that it is a message notification and what mailbox has the message.

 **CASCADE PAGING NOTIFICATION (FUNCTION 56)****CUSTOMER REQUIREMENT**

A company with an after-hours tech on call wants the tech paged when an emergency message has been taken, then add the supervisor if not responded to within one hour, and then add the Department manager if not answered after another hour.

PROGRAMMING TECHNIQUE

A Cascade Paging Mailbox 520 would be set up for the Tech Department. Calls could be call forwarded to the mailbox either as a no answer from the tech support Department pilot or as a result of the caller selecting "emergency page" as one of the options presented by the Auto Attendant during Night Mode (see Auto Attendant examples in this section). The worksheet example is:

MB	1ST NO.	TIMES	2ND NO.	TIMES	3RD NO.
520	4228621	4	5962322	4	5966565

Note: In the above example, the on-call-pager (4228621) would be passed to the Tech on duty each night. 5962322 belongs to the supervisor and 5966565 belongs to the Department manager. The period of time before the next pager is added is a function of the number of times programmed here and the interval programmed in Function 55.

NOTES:

SYSTEM PROGRAMMING

The section provides detailed descriptions of each programming function. It assumes that the prior sections and the Power User's Guide have been read carefully for an indepth understanding of the system's features.

IVX can be programmed from any extension and while the system is operating. Once Programming Mode has been accessed, the system will prompt and confirm each keystroke action via voice commands and the LCD display. Both configuration data and recordings are programmed in the same manner.

PROGRAMMING KEYS

<u>To</u>	<u>PRESS</u>	<u>DESCRIPTION</u>
Enter	#	Acts as an enter key to confirm a new or existing entry and advance to the next programming step.
Back-Up	*	Backs up to the previous prompt without changing its value.
Delete	HOLD	Deletes data or recording.
Exit	Hang Up	Exits programming mode and removes the extension from DND.
Help	PROG/HELP	Press during programming for more detailed instructions.
Select	PARK 3	Will toggle or scroll through possible selections on the LCD Display.

Note: A > at the end of the second line of the display indicates that additional choices or values can be toggled to or scrolled through by pressing the PARK 3 Key.

During Programming, the top line of the LCD will display the current item being programmed and the bottom line will be the "input" line.

Values can be input as directed by the combination of the voice prompts and LCD display. Multiple inputs such as a list of extension numbers are input and separated by #, ## will exit the list. When different choices are possible, press PARK 3 to scroll through the possible choices. If a long list has previously been entered, PARK 3 will scroll the list across the LCD.

INPUTTING ALPHABETIC/NUMERIC CHARACTERS

Names for Extensions, Departments, and Branch IDs can be input by pressing the dial pad key that corresponds to the character to be entered. The key's possible entries will change each time the key is pressed. When the desired character is displayed, press # to confirm, and the cursor will move to the next character position.

Example: To input a 'B', press the '2' key twice (the possible options to scroll through are A, B, C, 2). When B is displayed, press # to confirm and to move to the next character to be input. Press the HOLD Key to delete any errors. ## completes the name.

Note: The '1' key options are: Q, Z, _ (a space), 1.

ACCESSING USER STATION PROGRAMMING

Should a user forget his password or if an employee leaves the organization, this feature allows the Installer or Administrator to enter a user's station programming and operate within it as if he were the user. From the user's station, input the Installer or Administrator password when the system prompts for the user password.







Example: From station 105 entering 789# or 456# instead of the user password (105#), will enter the station for user programming (default passwords are used here for example purposes).

SYSTEM NUMBERING PLAN

The system's fixed numbering plan is as shown:

1 to 16	CO Lines
100	Operator Extension (default)
100 to 131	User Extensions
191 to 192	Analog Extensions
200 to 209	Department Pilots
300 to 499	Guest / Info Mailboxes
500	Broadcast Mailbox
501 to 516	Group Mailboxes
520 to 529	Cascade Paging Mailboxes
530 to 550	Recordable System Prompts
560 to 589	Feature Codes
590 to 598	MOH Recordings
600 to 699	System Speed Dial

SYSTEM PROGRAMMING OVERVIEW

-  **1 System Parameters**
 - 11 Initialize
 - 12 Installer Password
 - 13 Administrator Password
 - 14 Set Time / Date
 - 15 System Timing Parameters
 - 151 Flash Duration
 - 152 Transfer Recall Timer
 - 153 Hold Recall Timer
 - 154 ACD Exit Timer
 - 155 ACD Wrap Timer
 - 16 Recording Alert Tone
 - 17 System Speed Dial
 - 18 Serial Port Baud Rate
-  **2 CO Line Programming**
 - 21 Line Programming
 - 22 Toll Restriction Programming
 - 221 Centrex/PBX Access Code, 222 Toll Restriction Exception Tables
 - 23 CO Line Parameters
 - 231 Line Receive Volume, 232 Line Open Loop Interval
 - 24 Caller ID Programming
-  **3 Extension Programming**
 - 31 Extension Definition & Routing
 - 32 Extension Feature Authorization
 - 33 Department Programming
 - 34 Analog Extension Programming
 - 35 Extension Button Mapping
-  **4 Auto Attendant Programming**
 - 41 Auto Attendant Branch Programming
 - 42 Announce Extension Number
 - 43 Automatic Day / Night Mode Table
-  **5 Voice Mail Programming**
 - 51 Maximum Message Length
 - 52 Message Purge Control
 - 53 Guest / Info Mailboxes
 - 54 Group Mailboxes
 - 55 External Paging Programming
 - 56 Cascade Paging Mailboxes
-  **6 Recording**
 - 61 Record System Prompts
 - 62 Record Directory Names
 - 63 MOH Programming
 - 631 MOH Source
 - 632 Record MOH
 - 633 MOH Volume
-  **7 Reports**
 - 71 System Program
 - 72 Line / Auto Attendant Statistics
 - 73 Extension / Department Statistics
 - 74 Voice Mail Statistics
 - 75 System Speed Dial List

ENTER PROGRAMMING MODE

Programming Mode is entered by pressing the PROG/HELP Key. During play of the normal station programming menu, press PARK 3 to stop the station programming prompt, input the Installer Password, and follow the system programming menu.

Note: While in the Programming Mode, the extension will be automatically placed in DND until the Programming Mode is exited by hanging up.

FUNCTION 1 SYSTEM PARAMETERS

FUNCTION 11 INITIALIZE

This function will either:

1. RESET

Will erase all programmed configuration data but will not delete custom recordings made by the Installer or customer. After Reset, the system will match any previous custom recordings to the new configuration data.

2. INITIALIZE

Returns all components and software to their initial state. Initialization will erase all data and custom recordings. **Always initialize the system before initial programming.**

The command to reset or initialize must be confirmed by entering the Installer Password when prompted.

Note: System Reset or System Initialization may take up to 2 minutes to complete. When completed, the phone's display will return to the idle state. Programming mode must be re-accessed by following the above steps.

IVX FUNCTION 12 & 13 INSTALLER & ADMINISTRATOR PASSWORDS

These functions will display the existing password and prompt for input of a new password. The passwords can be 2 to 8 digits long. The Installer can change either the Installer or Administrator Password. Only those functions listed in the Administrator's Manual can be programmed via the Administrator Password. The default passwords are:

Installer Password (Function 12) = 789
Administrator Password (Function 13) = 456.

Note: Be sure to write down the new passwords in a safe place and give the new Administrator's Password to the Administrator.

Note: The Installer or Administrator can access a user's station programming. At the user's station, when prompted to enter the User's Password, input the Installer or Administrator Password and follow normal user programming.

IVX FUNCTION 14 SET TIME / DATE

A new time is input in a twelve hour format. Input "1233" for 12:33, or "315" for 3:15. Select AM or PM by pressing the PARK 3 Key.

A new date is input in an eight digit format including leading zeros. For 7/4/98 input 07041998#.

Note: A built-in battery will maintain the correct time and date, even in the event of a power loss.

IVX FUNCTION 15 SYSTEM TIMING PARAMETER

IVX FUNCTION 151 FLASH DURATION

The flash hook duration sets the time (in tenths of a second) that a flash hook will generate a fresh CO dial tone. The range is 0.2 sec to 2.0 sec. Default = 1.5 sec

IVX FUNCTION 152 TRANSFER RECALL TIMER

The transfer recall timer sets the number of times a transferred call will ring before being forwarded to the extension's mailbox (or recalled if no mailbox exists). The range is 1 to 9 rings. Default = 3

IVX FUNCTION 153 HOLD/PARK RECALL TIMER

The hold/park recall timer is the amount of time in seconds that a call will remain on hold or park before recall. The range is 5 to 960 seconds. Default = 60

IVX FUNCTION 154 ACD EXIT TIMER

The ACD exit timer is the amount of time in seconds that a call will remain in ACD Department queues (see Function 33). The range is 5 to 600 seconds. Default = 180

IVX FUNCTION 155 ACD WRAP TIMER

The ACD wrap timer is the maximum amount of time in seconds that an agent can remain in wrap mode. If this function is turned off, agents cannot place their stations in Wrap Mode (see Power User's Guide, ACD Agent). If turned on, the range can be set from 5 to 600 seconds. Default = 0 (No limit)

IVX FUNCTION 16 RECORDING ALERT

When using the recording feature to record an outside call, the system can be set to play a short beep tone every 15 seconds to indicate to both parties that recording is in progress. Default = Disabled

In most jurisdictions, a conversation is permitted to be recorded if one of the two parties is aware that it is being recorded. However, ESI takes no responsibility as to its legality in all jurisdictions. It is the responsibility of the installing company and the end user to determine and follow the applicable state and local laws regarding recording of conversations.

FUNCTION 17 SYSTEM SPEED DIAL

Up to 100 System Speed Dial names and associated numbers can be stored (in location numbers 600 to 699) for access by any station. A user can initiate a speed dial by dialing the location number (600 to 699).

Enter the 3 digit location number to program, a ten character name, and the number to be dialed (including the line group 9, 8, or 7) .

The number can be up to 30 digits long including the additional characters: #, *, F (flash), or P (a 2 second pause). These are inserted by pressing the PARK 3 Key to select the desired character: #, *, P or F. Press # to confirm the inserted character and continue. Press ## to complete the entry.

Example: to create a System Speed Dial number that dials 9, 578-5644, pauses for 4 seconds, and dials #104 input: 95785644, (Tab to) P, #, (Tab to) P, #, (Tab to) #, #, 104 #.

Press the HOLD Key to delete any character or digit entered in error. To delete an entire speed dial number and name, delete the location number by pressing the HOLD Key.

Note: System Speed Dial will be available to all stations regardless of the station's line access or toll restriction.

FUNCTION 18 SERIAL PORT BAUD RATE

The baud rate for the system's serial port is selected by pressing the PARK 3 Key until the desired rate is displayed. Press # to confirm. The possible rates are: 300, 1200, 2400, 9600, 19.2, or 38.4. Default is 38.4.

Note: The output from the serial port is: 8 data bits, 1 stop bit, and no parity. The pinout is: Data Transmit – Pin 2, Receive – Pin 3, and Ground – Pin 5.

FUNCTION 2 CO LINES

The system operates as a PBX or as a combined KEY/PBX (default).

In combined KEY/PBX Mode the CO Lines appear as Line Keys on the upper Soft Feature Keys. CO Lines are accessed by pressing one of these keys or by dialing 9 (8 or 7). In PBX Mode, the user always accesses CO Lines by dialing 9 (8 or 7).

Note: To provide additional visual indication of CO Line usage, the LCD Display of idle phones will show on/off-hook line status.

Since the system handles call transfer and Auto Attendant functions efficiently, operating in the PBX mode provides more Soft Feature Keys for other use and the opportunity for glare is greatly reduced.

During initial programming, selecting either PBX or KEY/PBX Mode and entering the number of CO Lines to be installed will automatically program the Soft Feature Keys system wide. Use Extension Button Mapping (Function 35) for system-wide changes or station Soft Feature Key programming to selectively change individual station Soft Feature Keys.

KEY/PBX MODE

The Line appearances on the Soft Feature Keys will be assigned starting with the upper-left key as Line 1 and fill to the right. The station appearances will be automatically filled starting with 100 at the far left-hand key of the next empty row of keys following the Line keys.

PBX MODE

The station appearances will begin with 100 as the upper-left key and fill to the right all available keys as Station Keys.

Note: To later add a CO Line, be sure to re-assign its existing Soft Feature Key to another location.



FUNCTION 21 CO LINE PROGRAMMING

Up to 16 CO Loop Start Lines can be connected to the system (8 to the standard cabinet and 8 to the expansion cabinet). The CO Lines are numbered 1 to 16.

All CO Lines are programmed to route callers during the Day Mode then all CO Lines are programmed to route callers during the Night Mode. The LCD Display will indicate DAY or NIGHT to distinguish which mode is currently being programmed.

See the Tutorial (Section 2) for programming examples. Below is an example of a completed Programming Worksheet. The sequence of programming is as follows:

- 1.
- 2.
- 3.

<u>CO</u>	<u>OUT</u>	<u>Ring 1</u>	<u>Ring 3</u>	<u>Ring 5</u>	<u>Ring 9</u>
1	9	100	100	100	ID1

EACH PROGRAMMING STEP IS DEFINED AS FOLLOWS:

1. CHOOSE CO LINES TO PROGRAM

Select the Line Keys to be programmed alike (their LEDs will become green when selected). After programming these keys (they will turn amber), select additional Line Keys to program alike until all required Lines have been programmed (and turned amber). Repeat this for the Night Mode.

2. OUTBOUND CO LINE GROUPS

CO Lines can be grouped for outbound pooled access into one of three Line Groups (9, 8, or 7).

Note: A Line can only be in one Line Group.

Outgoing calls, if selected by dialing 9, 8, or 7 access; will be assigned in order from the highest numbered CO Line to the lowest in the group. If a CO Line is not assigned to a Line Group, it will be an inbound line only (press the HOLD Key to delete the Line Group number).

Default is all CO Lines in Group 9.

If KEY/PBX Mode is used, the Line Group assignment for each line chosen in this programming step will dictate the location of the Line Keys in the Soft Feature Keys. The Line Keys for each group will only appear at the stations that are permitted to access to that Line Group as programmed in Function 31.

Example: A system set to operate in KEY/PBX Mode has 7 Lines. 1 to 4 in Line Group 9, and 5 to 7 in Line Group 8. Lines 1 to 4 will appear on the top four keys of the Soft Feature Keys at the stations assigned to Line Group 9. Lines 5 to 7 will appear in the left hand three keys of the second row on the stations programmed to access Line Group 8. Use extension button mapping to change if desired.

3. ANSWER RING ASSIGNMENT

Lines can be directed to be answered at up to 5 Extensions, a Department, a Mailbox or an Auto Attendant Branch ID (see Auto Attendant Programming). The destination can be set to add or drop Extensions, Departments, MBs or IDs if ringing continues due to no answer (see examples in the Tutorial Section).

Default is answer on Ring 1 with ID1 (Main Greeting) in both Day and Night Mode.

Program all desired CO Lines in Day Mode and repeat the programming steps for all desired CO Lines in Night Mode.

☒ FUNCTION 22 TOLL RESTRICTION

☒ FUNCTION 221 CENTREX/PBX ACCESS CODE

If the system is to be used behind Centrex or another PBX, the number of digits in the dial access code used to access a CO Line from Centrex or the PBX must be listed so that toll restriction can ignore the digit(s). The Access Code can be a one or two digits such as 9, 81, etc.

☒ FUNCTION 222 TOLL RESTRICTION EXCEPTION TABLES

The system's toll restriction is based on outbound calls being defined as either toll calls or non-toll calls.

Toll calls are: all 1+ calls, information, operator, international, 1-900 and 976 calls.

Non-toll calls are: all 7 and 10 digit local calls, and all 1-800 or 1-888 calls.

As part of Extension Feature Authorization (Function 32), each station is programmed to be allowed or denied toll calls. All stations can make non-toll calls.

An Allow Exception Table and a Deny Exception Table can be programmed in this function to be exceptions to toll restriction. If a number is listed in the Allow Table, it will be allowed to all stations. If a number is listed in the Deny Table, it will be denied to all stations.

List the numbers for either table separated by #. ## to end the list. Press the Mute/DND Key to insert a "wild card" digit. The numbers input will be applied to their most significant digit. Do not include IVX's Line access 9, 8, or 7 in any of the toll restriction entries.

Example: If 1304 is input into the Deny Table, then all 1+ calls to area code 304 will be denied; if 12095458787 is input then only calls to that number will be denied. To allow information calls, input into the Allow Table: 411, 1411, 5551212, 1XXX5551212 (where X is a wild card digit).

☒ FUNCTION 23 CO LINE PARAMETERS

☒ FUNCTION 231 LINE RECEIVE VOLUME

Many variables can affect the volume of the CO Lines. Weak lines can reduce IVX's ability to properly detect DTMF dialed by an outside caller. Conversely, "hot" lines can cause DTMF distortion and/or increase the opportunity for message talk-off (eg messages being cutoff before completion). The ideal setting is when a message recorded from an outside call has the same playback volume as the system prompts.

This function can be used to adjust the receive volume of the CO lines to help compensate for hot lines. The range is 0 (lowest) to 12 (the highest gain possible). Default = 12

☒ FUNCTION 232 LINE OPEN LOOP INTERVAL

If an open loop interval is available from the CO, IVX can be set to detect the open loop interval and disconnect more quickly. This will also allow the system to drop abandoned calls from Park and Hold and to reduce the possibility that abandoned calls could create messages that are silent or contain CO generated tones.

Since open loop intervals generated by the CO may vary in duration, use this function to program IVX to match the CO open loop interval. If this programmed value is set too low, IVX may falsely interpret static or a momentary loop break as an open loop and disconnect a caller in the process of leaving a message. If this value is set too high, IVX may not detect a valid open loop signal for fastest call processing.

The range is 1 to 255 in 10ms steps. 0 will turn Open Loop Detect off. Default = 6 (60ms)

 **FUNCTION 24 CALLER ID**

This function activates the Caller ID capability in IVX— provided that Caller ID service has been ordered from the telco. IVX will show the caller's name in the display for incoming calls or messages (or show the Caller ID number if the CO only provides a number). If no information is transmitted (unavailable, blocked, etc.), IVX will provide the normal non-Caller ID display for that particular call.

Auto Callback— is accomplished by pressing the FLASH/RDL Key during message playback. Caller ID numbers received from the CO are 10 digits long (and include the area codes for local calls). In Auto Callback, IVX dials the call as a long distance call by adding a 1 prefix in front of the 10 digits.

A table of exception area codes can be input to indicate that calls to those area codes are to be dialed as local calls. Two types of local dialing can be programmed:

Local 7 – local calls that can only be dialed as 7 digits (IVX will strip the area code received before dialing).

Local 10 – local calls that can only be dialed as 10 digit numbers (IVX will not add a 1 prefix).

If you have an area code that can be called as a long distance number (with a 1 prefix) and as a local number (10 digits without a prefix), then you must decide which case is the more prevalent and add to or exclude from the area codes exception list accordingly. Therefore some of these calls will have to be made manually.

Note: Since the Caller ID information is transmitted from the CO during the silence between the first and second ring, turning this feature on will delay the answer of inbound calls until the second ring.

**FUNCTION 3 EXTENSION PROGRAMMING**

This section provides programming for: Extensions, Department Groups, and Analog Ports.

**FUNCTION 31 EXTENSION DEFINITION & ROUTING**

Extensions are numbered 100-131. See the Tutorial (Section 2) for programming examples. Below is an example of a completed Programming Worksheet (Section 6). The sequence of programming is as follows:

1. 2. 3. 4. 5. 6. 7.

<u>EXT</u>	<u>NAME</u>	<u>CO</u>	<u>CF DAY</u>	<u>CF NIGHT</u>	<u>PGZN</u>	<u>EXT</u>
0	OPERATOR		X100	X100		X100
100	JANE	9	MB100	X105	1, 2	
101	ROGER	9	MB101	MB101		
102	SALLY	9, 8	MB102	MB102	1	
103	DSS					X100

* 100 is defaulted as OPR (when a user dials 0). 101 is an example of system default.

Each programming step is defined as follows:

1. EXTENSION NUMBER

Extension numbers are defaulted from 100 to the highest number of ports installed and must match the port numbers as connected to the system.

2. EXTENSION NAME

The name is used for the LCD Display, reports, and as a programming aid. The name length can be no longer than 10 characters (See Inputting Alphabetic/Numeric Characters earlier). Default = the extension number.

3. CO LINE GROUP

Assigns the extension's ability to access one or more CO Line Groups (9, 8, and 7). Default = 9

4. & 5. CALL FORWARD BUSY/NO ANSWER

The extension can be set to call forward busy/no answer to another Extension (or Department), a Mailbox or a Branch ID for Day Mode and differently for Night Mode. Default = the extension’s mailbox

6. EXTENSION PAGE ZONE ASSIGNMENT

List the page zones (1, 2, 3) that are to include this extension.

Note: All extensions are included in the All Page Zone. Default = 0 (All Page)

7. OPERATOR TRANSLATION AND DSS/BLF CONSOLE

Operator Translation– Extension 0 (Operator) programming requires: naming the extension and programming Call Forwarding for day and night mode, and inputting the extension number to which calls are to be directed when someone dials 0. Default = 100

DSS/BLF Console– An extension is designated as a DSS/BLF Console by programming its extension name with “DSS”. When prompted input the extension number that it is to be “paired” with.

Note: Only one DSS/BLF Console can be installed per Port Card but each can be paired with any extension in the system.



FUNCTION 32 EXTENSION FEATURE AUTHORIZATION

Many extension features can be allowed/denied on a extension-by-extension basis by the Installer or Administrator. Users can only program allowed features by using a combination of voice and LCD prompts from their phone.

See the Tutorial (Section 2) for programming examples. Below is an example of a completed Programming Worksheet. The sequence of programming is as follows:

1.	2.	3.	4.	5.	6.	7.	8.
<u>EXT</u>	<u>NAME</u>	<u>CAMP</u>	<u>DND</u>	<u>AA BLOCK</u>	<u>REC</u>	<u>S/OB</u>	<u>TOLL</u>
XXX	Default	Y	Y	N	N	N	Y
100	JANE	Y	Y	N	N	N	Y
101	ROGER	Y	Y	N	Y	N	Y
102	SALLY	Y	Y	N	N	N	Y

The programming steps are:

1. EXTENSION NUMBER

Enter the extension number to program.

2. EXTENSION NAME

Name the extension (if not previously named in Function 31).

For each of the following features, press the PARK 3 Key to select YES or NO. See General Description (Section 1) and the Tutorial (Section 2) for detailed description of each.

3. CALL WAITING

Allows the user to turn call waiting on or off for his station.

4. DO NOT DISTURB

Allows the user to activate DND from his station.

5. AUTO ATTENDANT BLOCK

Blocks calls from being transferred to the station from the Auto Attendant.

6. LIVE RECORDING FEATURE

If enabled, will allow the user to record conversations.

7. SERVICE OBSERVING

Allows the user to monitor the conversations of those stations listed in the Service Observing list for his station. If Service Observing is YES, a list of allowed extensions must be input.

Note: A Department number can be entered as an extension in the Service Observing list and will then automatically include all members of the Department even if the members of the Department are later changed.

8. TOLL RESTRICTION

Allows the user to place toll calls. If denied, the user can only make non-toll calls or calls to numbers listed in the Allow Exception Table.



FUNCTION 33 DEPARTMENT PROGRAMMING

Up to 10 Departments (hunt groups) can be created with a maximum of 32 extensions in each. An extension can be assigned to more than one Department. Department numbers range 200 to 209.

A Department can be designated to be rung in one of the following methods: All, In Order, UCD or ACD. A Department can also be designated as a Pick-Up group.

DEPARTMENT HUNTING METHODS

IN ORDER

Calls will ring each phone in the order listed. If all are busy or none answer, the call will call forward as programmed here.

ALL

Calls will ring all listed phones at the same time. If no extension answers or all are busy, the call will call forward as programmed as part of this function.

UCD

Calls will be rotated evenly throughout the listed extensions. If none answer or all are busy, the call will call forward as programmed here.

ACD

Calls will be presented to the longest idle logged-on agent. If all agents are busy, the caller will be played the ACD Queue Prompt and placed in queue. When an agent becomes available, the longest holding caller will be connected. If no agents answer before the Exit Time (Function 154) is reached, the call will call forward as programmed in this function.

Caller holding in an ACD Department queue will be connected to music/message-on-hold, during which time the caller can dial options presented such as 0 for the operator. While on hold, the caller is periodically played prompts to continue to hold for an available agent.

The ACD Queue Prompt (Prompt 538) is played when all extensions are busy and the first time the caller has been put on hold (*"All extensions are busy, please hold and your call will be answered in the order received"*); and ACD Hold Prompt (Prompt 539) is played at a 60 sec interval (*"All extensions are still busy, please continue to hold"*). These prompts can be re-recorded in Function 61 (Re-Record System Prompts).

Agent Log On Keys will be automatically assigned to the lower left Soft Feature Keys for the stations listed in ACD Departments. Stations can later be added to or deleted from ACD Departments by creating or deleting Log On Keys as part of their station programming (See Power User's Guide).

PICK-UP ONLY

Allows for creation of a traditional pick-up group. Calls cannot be directed to a Pick-Up Only Department. An extension can only be assigned to one Pick-Up Only Department. A Soft Feature Key must be programmed on phones that are to use this feature.

Note: Usually a caller will be forwarded to a Department by the Auto Attendant. However, a user can also transfer a caller to the Department number. The transferred call will be processed according to the above description as if transferred by the Auto Attendant.

See the Tutorial (Section 2) for programming examples. Following is an example of a completed Programming Worksheet.

1. 2. 3. 4. 5. 6.

<u>EXT</u>	<u>NAME</u>	<u>TYPE</u>	<u>CF DAY</u>	<u>CF NIGHT</u>	<u>LIST:</u>
200	SALES	IN ORDER	MB102	MB102	104, 112, 115
201	SERVICE	ACD	0	MB301	101, 102

Each programming step is as follows:

1. DEPARTMENT NUMBER

Department numbers range from 200 to 209.

2. NAME

The Department name is used for the LCD Display, reports, and as a programming aid. The name length can be up to 10 characters (See Inputting Alphabetic/Numeric Characters earlier in this section). Default = the Department Number.

3. TYPE

The Department type is selected from one of the five possible types (All, In Order, UCD, ACD, Pick-up). Default = In Order

4. & 5. CALL FORWARD BUSY / NO ANSWER

The Department can be set to call forward busy/no answer (for all extensions in the Department) to an Extension, another Department, a Mailbox or a Branch ID for Day Mode and differently for Night Mode.

Default = 100

Note: Calls routed to an extension via a Department will follow the Department's Call Forwarding. While calls transferred to the extension will follow the station's Call Forwarding as programmed in Function 31.

6. DEPARTMENT LIST

Input the extension numbers that are assigned to this Department. **Note:** A new list of extension numbers must be entered if a department has previously be programmed as a different type Department.

Note: the order that the extension numbers are entered will dictate the order called when the Department Type selected is "In Order".



FUNCTION 34 ANALOG EXTENSION PROGRAMMING

Two pre-assigned analog ports (X191 and X192) provide support for the following applications:

Common Ringer— Connected via a Tip and Ring pair will apply ring voltage whenever a Line rings in Night Mode.

FAX— If a FAX tone is detected by the Auto Attendant, it will automatically be forwarded to the Analog port programmed as FAX.

Modem— Incoming calls for a Modem can be manually transferred to the Modem extension. Outbound calls can be automatically generated by the Modem.

Overhead Paging Interface— Connects via a Tip and Ring pair to an overhead paging amplifier designed to answer upon receiving ring voltage. **Note:** Many paging units are designed to be connected to a CO Line port and can be connected to IVX accordingly.

Door Phone— A telephone connected to this port will automatically dial the ring down extension number programmed whenever the set is taken off-hook.

Phone— Designed to provide limited 2500 set capability (only able to make, transfer, or answer calls).

Default is 191 for FAX and 192 for PAGE.

Each programming step is as follows (only the appropriate steps for each type will be required):

1.	2.	3.	4.	5.	6.	7.
EXT	TYPE	CO	RING DN	CF DAY	CF NIGHT	TOLL
191	FAX	9		ID9999	ID9999	Y
192	DOOR		0	ID9999	ID9999	
xxx	RINGER					
xxx	MODEM	9		ID9999	ID9999	Y
xxx	PAGE					
xxx	PHONE	9		X0	X0	Y

Each programming step is as follows:

1. EXTENSION NUMBER

Select either 191 or 192 by pressing the PARK 3 Key.

2. TYPE

Select the type by pressing the PARK 3 Key.

3. CO LINE

Off hook preference can be either dial 9, 8, or 7 (to a CO Line Group) for FAX, Modem, or Phone. Default is 9. Off hook preference will be to an extension for door phone. No dial tone is presented for Common Ringer or Overhead Paging.

4. RING DOWN

A Ring Down destination can be programmed only if the type selected is DOOR. Enter an Extension, Department, or Mailbox to ring whenever the station is taken off-hook. Default = 0 (the operator)

5. & 6. CALL FORWARD BUSY / No ANSWER

The ports can be set to call forward busy/no answer to an Extension, Department, Mailbox or a Branch ID for Day Mode and differently for Night Mode. Default = 9999 (automatic disconnect).

7. TOLL RESTRICTION

Allows the port to originate toll calls. If denied, the ports can only originate non-toll calls or calls to numbers listed in the Allow Exception Table. Default is Allow.



FUNCTION 35 EXTENSION BUTTON MAPPING

The initial system-wide Soft Feature Key positions are dictated as a result of the CO Line Programming (Function 21). Function 35 can be used to change those system-wide positions. Further, users can change the Soft Feature Key positions for their stations as part of station programming. Removing the Line Key appearances will set the system to operate as a PBX with line access by dialing 9 (8 or 7).

Warning: Future, system-wide changes made here by the Installer will overwrite any station user programming. When prompted, press the desired Soft Feature Key location, then input the appropriate digits on the dialpad and confirm by pressing the same Soft Feature Key again.

Note: To determine how a Soft Feature Key is currently programmed, press the key, note how it is programmed, and press the key again.

CO LINE KEY

If the dialed digits are 1 thru 16, the key will serve as a CO Line key.

STATION KEY

If the digits input is a three digit extension number (or Department, Guest Mailbox, etc.), the key will become a Station Key providing the appropriate lamp information.

Department pilots numbers (200 to 209) programmed here will appear on all phones, however Agent Log On keys (5200 to 5209) will only appear at the phones of assigned agents in the corresponding ACD Department.

SPEED DIAL KEY

If 9 (8 or 7) plus a phone number are input, the key will become a Speed Dial Key for outside calls.



FUNCTION 4 AUTO ATTENDANT PROGRAMMING



FUNCTION 41 AUTO ATTENDANT BRANCH PROGRAMMING

IVX's Auto Attendant follows a branch concept whereby the caller is routed through a series of branches— ultimately to the extension he wishes to reach. He moves from branch to branch by selecting a number or name presented in a branch prompt.

The three branch types can be used to create limitless routing possibilities:

1. MENU BRANCH

A Menu Branch includes a prompt that instructs the caller to make a selection from the choices presented such as *“For sales press 1, for service press 2, or for admin press 3”*. Whenever a Menu Branch is created, the corresponding number of sub-branches must also be created to match the number of choices given the caller in the prompt.

When a caller makes a single digit selection, he will then advance to one of its sub-branches, which could be another Menu Branch if more choices are to be given, a GoTo Branch which will route the caller to his destination, or a Directory Branch so he can choose from a list of names.

Note: If a caller makes no selection during the prompt in a Menu Branch, he will be transferred according to the No Response programming for that branch.

2. GoTo BRANCH

A GoTo Branch transfers the caller to an Extension, Department, Mailbox, Branch ID, or an outside number:

GoTo AN EXTENSION OR DEPARTMENT

The GoTo Branch automatically blind transfers the caller to the Extension or Department number programmed as its destination. If the number listed is a Department, the system will follow the programming for the Department as set in Function 33.

If the destination Extension or Department dialed is busy or does not answer; the call will follow that Extension's or Department's call forwarding.

GoTo A MAILBOX

If programmed to GoTo a Mailbox, the caller will be routed to that mailbox's personal greeting. The mailbox can be a user, a Guest/Information Mailbox, a Group mailbox or Cascade Paging Mailbox.

GoTo A BRANCH ID

The GoTo Branch can also be used to jump to any other branch in the Auto Attendant. It is a good idea to provide a jump as a sub-branch of each Menu Branch giving the caller an exit should he not wish to select any of the choices played.

Example: *"For widget sales press 1, for gadget sales press 2, or to return to the Main Menu press 3."* In this case, the third sub-branch would be a GoTo Branch with ID1 (Main Greeting) as its programmed destination.

GoTo AN OUTSIDE NUMBER

The GoTo Branch can be used in conjunction with Centrex lines to transfer to an off premise location. It can be programmed to include in its "dial string" pauses, flash hooks, etc.

These special codes may be inserted by using the PARK 3 Key to select the appropriate code. Since the # key is used to confirm, a special code must be used to actually program a # DTMF tone if required. The codes are:

= a # DTMF tone,
F = a flash hook,
P = a 2 second delay, or
E = to send the last extension number attempted.

IVX will dial the string as programmed and release the call to Centrex to complete the connection.

Example: to create an outdial string that dials 9 pauses 2 seconds, sends a flash hook, dials 9, 578-5644, and goes on-hook, enter: 9, Tab to # P, #, Tab to F, #, 9, 5785644, ##.

3. DIRECTORY BRANCH

A Directory Branch allows the caller to be connected to an employee by selecting his or her name from a list played. Two types of directories are available:

ALL NAMES

The caller selects the person he wishes to reach from the playback of all recorded names.

BY ALPHA

The caller is prompted to input the first letter of the individual's first or last name. The matched names are then played to the caller in the order recorded. A second prompt then instructs the caller to press # when he hears the name of the individual.

Note: The actual recording of the names and alpha “key” input (if the directory type is By Alpha) will come later in Function 62, Record Directory Names. **The Branch(s) will not be enabled until at least 1 name has been recorded.**

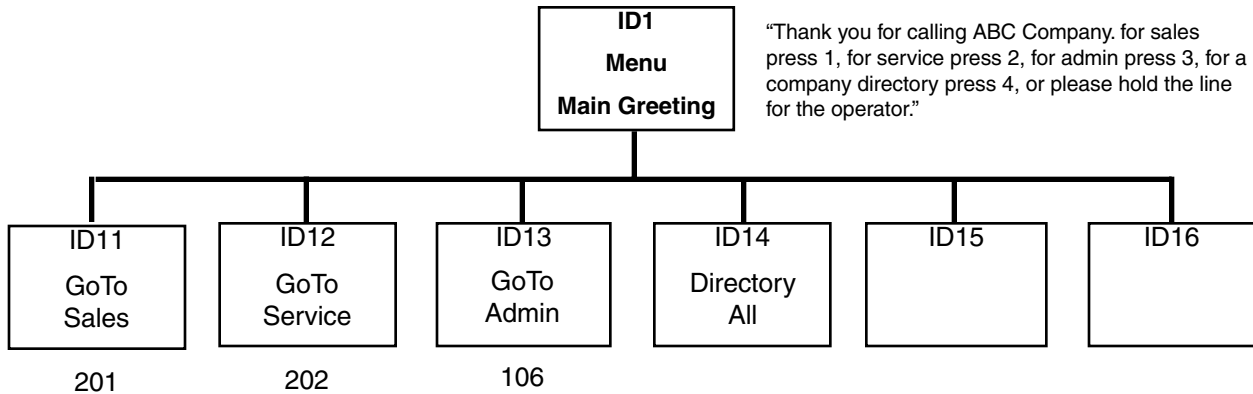

In the example above, the Branch IDs and Branch titles shown are for programming purposes only. The caller only needs to press 1, 2, etc. to move through the choices.

THE AUTO ATTENDANT SEQUENCE OF PROGRAMMING IS AS FOLLOWS:

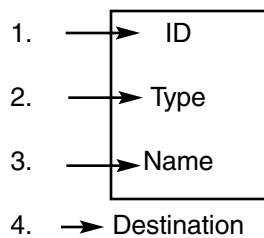

1. BRANCH ID

A numeric designator which indicates its location and relationship to the other branches. There can be up to 6 levels of branches, the first level being a single digit, the second level being two digits, and so on.

The Main Greeting is ID1 (or additionally 2 thru 8 if a different greetings for different Lines is desired), then each of its sub-branches will have that number plus an additional digit of its own (corresponding to choices given to the caller, shown here in bold): **11**, **12**, **13**, etc. Menu Branch 123 would have sub-branches **1231**, **1232**, etc.

2. TYPE

Select a Menu, GoTo, or Directory Branch.

3. NAME

Input the name to help identify the branch for later programming changes and is also the source for LCD display information at user's phones and reports.

4. DESTINATION

In a Menu Branch the destinations are always sub branches that are created later. In a GoTo Branch the destination is an Extension, another Branch ID, or a "string" of digits or commands for dialing outside of the system. In a Directory Branch the destination is a list of names (input in Function 62) which are then translated by the system to extension numbers and called.

AUTOMATIC DISCONNECT

If 9999 is programmed as a destination, the call will be automatically disconnected.

5. CALL FORWARD BUSY/NO ANSWER

Can be programmed (and will be prompted for) only if an outdial number is the destination of a GoTo Branch.

6. CALL FORWARD NO RESPONSE

Programmed (and will be prompted for) only for a Menu or Directory Branch.

TO DELETE A BRANCH

To delete a previously created branch, input the Branch ID, press the HOLD Key, and confirm by pressing the PARK 3 Key and #.



FUNCTION 42 ANNOUNCE EXTENSION NUMBER

If a caller selects a name from a Directory Branch, the system can be set to announce the extension number prior to transferring the call. This provides the caller with the extension number for future direct dialing from a Menu Branch such as the Main Greeting. This feature should not be used where individual privacy is desired. Default is On.



FUNCTION 43 AUTOMATIC DAY/NIGHT MODE TABLE

The Day/Night Mode Table is programmed by selecting the day of the week and then entering times associated with the start of each day and night mode period. The times are entered in military time. Up to 6 different times can be entered for each day.

Select the day of the week by pressing the Park 3, press # to confirm. Enter each time entry for the day displayed separated by #. The mode (day or night) associated with each time will be automatically selected by the system (press the Park 3 Key to change the mode). Press ## to return to the select the next day of the week to enter. Use Park 3 to select the next day to program or # again to exit Day/Night Mode Programming. The Hold Key will delete an entry.

In the example below, the company has Night Mode programmed for after normal hours, lunch time, Wed and Sat after 2:00 PM, and all day Sun.

DAY / NIGHT MODE WORKSHEET EXAMPLE:

<u>MON</u>	<u>TUE</u>	<u>WED</u>	<u>THU</u>	<u>FRI</u>	<u>SAT</u>	<u>SUN</u>
0800 D	0800 D	0800 D	0800 D	0800 D	0800 D	
1200 N	1200 N	1400 N	1200 N	1200 N	1400 N	
1300 D	1300 D		1300 D	1300 D		
1700 N	1700 N		1700 N	1700 N		

✉ 5 VOICE MAIL PROGRAMMING

To simplify initial installation, all programmed extensions will automatically have a generic personal greeting “*You have reached the mailbox for extension xxx*”. This greeting should be replaced with a personalized greeting by the mailbox user.

✉ FUNCTION 51 MAXIMUM MESSAGE LENGTH

Although the system will store only the actual message as left by the caller, the time set here is the maximum time to allow for a message. The range is from 1 to 10 minutes for messages. The maximum length of a Recording is from 1 to 60 minutes. The maximum number of messages and recordings in a mailbox, regardless of length, is 128. Default = 3 min for messages, 10 min for recordings.

✉ FUNCTION 52 MESSAGE PURGE CONTROL

To avoid having unneeded messages filling up the system's memory, values input here will establish how messages are to be automatically erased by the system if its memory becomes exhausted. The system's purge routine will begin only when the system's memory is full and will remove messages down to 90% full according to the following programmed values:

New Messages older than the number of days programmed,
Old Messages older than the number of days programmed,
Group Messages older than the number of days programmed,
Recordings that are older than the days indicated.

A "0" indicates that a type of message is not to be removed unless deleted by the user. The ranges are 0 to 365 days.
Default = 0, 0, 0, 0.

Example: to have old messages greater than 3 days old erased, group messages older than 5 days erased, and to not erase any new messages or recordings (if the system's memory becomes full): Input 0, 3, 5, 0 as prompted.

Note: If the memory becomes full and no message can be purged according to these values, callers will be played a “voice-mail-full” prompt until memory becomes available.

✉ **FUNCTION 53 GUEST / INFO MAILBOXES**

Mailboxes numbered from 300 to 499 can be programmed as either a Guest or Info Mailbox. Input the mailbox number and select Guest or Info by pressing the PARK 3 Key.

GUEST MAILBOXES

Guest Mailboxes are designed to be used by personnel such as outside sales or manufacturing personnel who do not have an extension assigned to them. A Guest Mailbox requires no programming other than the name assigned. Default = 300 to 499 as Guest

Note: A Guest Mailbox can be handled like a regular extension (i.e. listed in the Directory, assigned a Station Key, etc.).

A Guest Mailbox cannot have a message light. Messages are retrieved from the outside by dialing * and the mailbox number during the Main Greeting. Messages are retrieved from a station by pressing the VOICEMAIL Key, * and the mailbox number.

INFO MAILBOXES

Info Mailboxes can be used to give callers information on a variety of different subjects by “publishing” these mailbox numbers. Info Mailboxes are identical to Guest Mailboxes except that the caller will not be given a record tone after the personal greeting (the information to be played). Instead, the caller will be forwarded as programmed in this function (default is the caller will be disconnected after the information is played). The maximum length of the record time is 14 minutes.

Guest/Info Mailboxes are created or deleted here, but are turned “on” only when a personal greeting (the information to be played) has been recorded. Deleting the personal greeting will turn “off” the mailbox.

See the Tutorial (Section 2) for programming examples. Below is an example of a completed Programming Worksheet. The sequence of programming is as follows:

- 1.
- 2.
- 3.
- 4.
- 5.

<u>MB</u>	<u>NAME</u>	<u>TYPE</u>	<u>CF DAY</u>	<u>CF NIGHT</u>
300	DANA	GUEST		
302	LITERATURE	INFO	X/MB/ID	X/MB/ID

Each programming step is defined as follows:

1. MAILBOX NUMBER

Input a mailbox number 300 to 499.

2. NAME

The mailbox name is used for the LCD Display, reports, and as a programming aid. The name length can be no longer than 10 characters (See Inputting Alphabetic / Numeric Characters earlier in this section). Default = the Mailbox Number.

3. TYPE

Select a mailbox type: Guest or Info

4. & 5. CALL FORWARD (INFO MAILBOX ONLY)

An Info Mailbox can be set to call forward after the personal greeting has played to an Extension, Department, a Mailbox or a Branch ID for Day Mode and differently for Night Mode. Default = 999 (automatic disconnect)

 **FUNCTION 54 GROUP MAILBOXES (INCLUDING BROADCAST)****GROUP MAILBOXES**

Up to 16 Group Mailboxes (501 to 516) can be assigned (each Group Mailbox can have up to 32 members). These can be used by anyone (who knows the password) to leave messages for all users listed as members of that group. The Administrator or Group Mailbox "owner(s)" may set, or change the list of Group Mailbox members.

A Group Mailbox is turned "on" (able to record and playback messages) only when a mailbox greeting has been recorded by the user such as *"This is the Group Mailbox for East Coast Regional Sales"*, etc. Deleting the Group Mailbox greeting will turn "off" the Group Mailbox. Any outstanding messages will remain in its members' mailboxes until erased by each member.

To enter Group Mailbox 510 as a user, dial 510 and enter the password. This will allow the Group Mailbox owner or anyone with the password to record a group message. Press the VOICEMAIL Key, *, 510 to hear/delete any group messages that remain in the mailbox. Press the PROGRAM/HELP Key, *, 510 to program the Group Mailbox.

Note: If "0" is programmed as the password, anyone can leave group messages or program the Group Mailbox.

Note: If a user saves a Group Message, it will be saved as a "new" message.

BROADCAST MAILBOX

Mailbox 500 is a special Group Mailbox which can be used to leave messages for users who have their mailboxes turned on (who have recorded a personal greeting). The Broadcast Mailbox cannot have its user list edited. Guest Mailboxes are not included in the Broadcast group.

 **FUNCTION 55 EXTERNAL PAGING PROGRAMMING**

On a mailbox-by-mailbox basis, the system can dial to an external commercial paging network to activate a user's pager.

IVX will page when the first new message has been left in a mailbox and will repeat the page (at the interval of minutes programmed in this function) until the new message(s) have been deleted, saved or moved.

To initiate a page, the system will access the CO Line as programmed, dial the paging number (programmed by the user as part of his mailbox set-up), pause for the number of seconds programmed here, dial the mailbox number, # and go on hook. The user must program the pager number without the CO Line Group (9, 8, or 7).

See the Tutorial (Section 2) for programming examples.

The sequence of programming is as follows:

1. CO LINE ACCESS

Input the CO Line Group (9, 8, or 7) that is to be accessed for paging.

2. DIALING PAUSE

Input the pause in seconds that is to occur after the pager number has been dialed and before the mailbox number is to be dialed. The range is 0 to 20 sec. Default = 6 Sec

3. PAGING INTERVAL

Input the number of minutes for the interval between reminder pages. 0 for no reminder pages (ie. page once at the first new message). The range is 10 to 1440 minutes. Default = 30 min.

Note: If the Paging Interval has been set to 0, all three pagers in a Cascade Mailbox (see following function) will be paged simultaneously and only once when a new message is taken.

FUNCTION 56 CASCADE PAGING MAILBOXES

In addition to individual mailbox paging, up to 10 Cascade Paging Mailboxes (in range 520 to 529) can be created. These can be assigned to anyone that requires additional levels of paging beyond the single level available in all user mailboxes. The paging numbers and number of times each is to be paged before the next paging number is added are programmed in this function.

Up to three paging numbers of up to 24 digits each can be programmed by the user to be paged whenever a new message is taken in the mailbox. The system will page the first paging number (for the number of times listed) and then add the second paging number (for the number of times listed) and then add the third paging number and will continue to page all three pagers until the message has been retrieved. The period of minutes between pages is the interval set in Function 55 External Paging Interval.

 **FUNCTION 6 RECORDING** **FUNCTION 61 RE-RECORD SYSTEM PROMPTS****SYSTEM PROMPTS**

The system prompts are played to an outside caller at different points in the call routing or mailbox functions. These system prompts have been pre-recorded at the factory but may be re-recorded if preferred in a different voice or with different instructions.

AUTO ATTENDANT BRANCH PROMPTS

The Auto Attendant branch prompts (such as the Main Greeting or sub-menus) are also recorded here by inputting the Branch ID number as the prompt number.

PROMPT RECORDING

Practice the prompt by recording and re-recording – starting and stopping with the 1 key. When satisfied with its quality, press the # key to confirm. Deleting a recording by pressing the HOLD Key (instead of #) will return to the default recording (if a system prompt).

BUSY PROMPT 530

The Busy Prompt is played to the outside caller if an extension is busy. Default is: *"That extension is busy"*.

HOLD PROMPT 532

The Hold Prompt is played to the caller after he has made a menu selection or has input an extension number. Default is: *"One moment please"*.

Q / Z PROMPT 534

The Q/Z Prompt may be played to a caller who has selected an Alphabetic Directory. The caller is instructed to use the "1" key for the letters Q or Z since these two letters do not appear on the phone keypad. This prompt is played at the end of the first directory prompt and is played only if a name in the directory starts with a Q or Z. Default is: *"For the letters Q or Z use key number 1"*.

NO NAMES MATCHED PROMPT 535

This prompt is played to the caller if, in a Directory Branch, the first letter he selected does not have any names associated with it; or he has listened to all of the names played and has not made a selection. After this prompt is played, the system will forward the call to the Extension, Branch or Mailbox as programmed in call forward no response. Default is: *"No names matched, one moment please."*

LEAVE A MESSAGE PROMPT 536

To reduce the recording requirements for mailbox user, this prompt is played at the end of the mailbox user's personal greeting and instructs the caller as to how to leave a message or other options. Default is: *"To reach the operator press 0 or to leave a message begin recording at the tone. Press 1 when finished"*.

END OF RECORDING PROMPT 537

Plays after a caller leaving a message presses 1 to stop recording and instructs the caller as to other options. Default is: *"To continue this recording press 1, to return to the main menu press 8, or if finished press * and hang up"*.

ACD QUEUE PROMPT 538

The first prompt played to a caller when all extensions are busy in an ACD Department. Default is: *"All agents are currently assisting other customers, please hold and your call will be answered in the order received"*.

ACD HOLD PROMPT 539

Is periodically played to callers on hold in an ACD Department when all extensions are busy. Default is: *"All agents are still busy assisting other customers, please hold and your call will be answered in the order received"*.

HOLIDAY MAIN GREETING PROMPT 540

The Holiday Main Greeting is played to callers when the system has been manually placed in Holiday Mode. Default is: *"Thank you for calling, our office is closed in observance of the holiday. You may dial your party's extension, at any time, or please call back during normal business hours"*.

Note: Night Mode programming for call routing will be followed while in Holiday Mode.

**FUNCTION 62 RECORD DIRECTORY NAMES**

This function is accessible only if a Directory Branch has been created as part of Auto Attendant programming. First input the extension number, and then press 1 to begin recording of the associated name and press 1 when finished.

If the directory type is By Alpha (see Function 41), the name key (first letter of either the first or last name) must also be programmed in this function. The name key field is the numeric equivalent to the letters appearing on a phone keypad (for Q or Z use key number 1).

Make photocopies of the blank Worksheet for preparing directories and making future changes. As names change, the Administrator can enter this function and change any field via the Administrator Password.

**FUNCTION 63 MESSAGE ON HOLD PROGRAMMING**

MOH can be either live music (with an external music source connected to the MOH connector located on the side of the cabinet), or pre-recorded music/messages can be stored on the disk and played continuously to a caller on hold.

Three default, generic MOHs are stored as Prompt 591, 592 and 593. Prompt 591 is three minutes of uninterrupted music (for use with ACD if desired), Prompt 592 has periodic prompts to *"Please continue to hold"*, while 593 has periodic prompts to continue to hold or to dial 0 for the operator or dial an extension number if known.

Up to five custom MOHs can be loaded into the system by using a cassette recorder connected to the MOH connector and stored as prompts 594-598.

Note: The MOH prompts will be played as a loop since callers may be connected at different times during its continuous playback.

SOURCE TO CALLERS ON HOLD:

Prompt 590	Live external source
Prompt 591	Pre-recorded music
Prompt 592	Pre-recorded with "please continue to hold"
Prompt 593	Pre-recorded with "dial 0 or extension from hold"
Prompt 594-598	Customer recorded message on hold

Note: If ACD is used, it is recommended that Prompt 590, 591 or a custom prompt without periodic “voice-overs” be used since the ACD Hold Prompt will also be played while a caller is on hold.

FUNCTION 631 MOH SOURCE

This selects the source that will be played to callers on hold. The range is 590 to 598. Default = 591 (generic Message on Hold)

FUNCTION 632 MOH RECORDING

Connect the message/music source to the MOH port on the side of the cabinet, input the prompt number to be recorded, press 1 to begin recording, press 1 when finished. To aid in queuing, the source will be played through the phone’s speaker while recording. The recorded material will then playback just as any other recording, press # to accept the recording. The recorded material should not have a “beginning” or “end” so that playback can loop continuously.

FUNCTION 633 MOH VOLUME

If an external audio source such as a radio is used for MOH, the volume should be adjusted at the radio. If a custom MOH is recorded, the output volume can be adjusted in this function.

The range is 1 (lowest) to 12 (maximum volume).
Default = 6.



FUNCTION 7 REPORTS

SERIAL PRINTER

Connect a standard serial printer to the serial port of the system. The output from the serial port is: 8 data bits, 1 stop bit, and no parity. The baud rate is programmed by the Installer in Function 18. The pinout is: Data Transmit – Pin 2, Receive – Pin 3, and Ground – Pin 5.

PC INTERFACE

Connect a computer serial port to the serial port of IVX. Use a standard PC communications program such as *ProCom* to port the data to the PC. When printing from the PC to a laser printer use a Fixed Proportional Font such as Courier New, 9 points or smaller.

From either the Installer or Administrator programming menu select the desired report as listed below. The reports can be printed with either: (1) the data saved for inclusion in future reports, or (2) the data and totals cleared. The System Program Report or System Speed Dial Report cannot have its data cleared.

Note: Outbound calls shorter than one minute are not counted in system totals.



FUNCTION 71 SYSTEM PROGRAM REPORT

This report provides a hard copy of the system's current programming. This report can be compared against the Programmers Worksheet to verify the accuracy of the programmed data.



FUNCTION 72 LINE / AUTO ATTENDANT REPORT

This report provides statistics to aid in analysis of Line usage and requirements.



FUNCTION 73 EXTENSION / DEPARTMENT REPORT

This report provides extension usage.

**FUNCTION 74 VOICE MAIL STATISTICS REPORT**

This report provides statistics indicating the message activity in each mailbox since the data was last cleared.

**FUNCTION 75 SYSTEM SPEED DIAL REPORT**

This report lists the current System Speed Dial numbers. Distribute a copy to those who are authorized to use them.

NOTES

TROUBLE SHOOTING

The following test procedures are designed to isolate a failed component of the total installation. This might include the System Cabinet, CO Line Ports, Station Ports, wiring, Feature Phones, or system programming errors.

Note: Before performing any of the following checks, be sure that the system is properly grounded and that a clean power source is being used. Double check all wiring continuity before proceeding.

SYSTEM DOES NOT COME UP OR POWER LED DOES NOT LIGHT

Verify that intercom dial tone and the Idle LCD Display is not available at all stations.

STATION SPECIFIC

If the above condition occurs at a single station, see Station Inoperable.

SYSTEM-WIDE

1. Check that the power transformer is solidly connected at the 110v outlet and at the power jack of IVX.
2. Verify that the transformer is outputting 24v AC.
3. Remove the case lid and verify that all cables are thoroughly seated.

Note: When the system is powered-up, up to 45 seconds may elapse before the software is fully loaded and the Power LED lights.

No CO DIAL TONE

STATION SPECIFIC

If the above condition occurs at a single station, see Station Inoperative below.

SYSTEM-WIDE

1. Check for Dial Tone at the telco demarcation block.
2. Check the wiring from the demarc to IVX. See Block Wiring Diagram on page 2.7.
3. Verify that the CO Line programming (Section 4) for each Line is correct to allow Line access.
4. Verify that the Extension Programming (Section 4) is correct to allow Line access from the extension.

CAN'T ACCESS CO LINE

Intercom and CO Dial Tone are available from a station but the Line cannot be accessed.

1. Verify that the CO Line programming (Section 4) for each Line is correct to allow Line access.
2. Verify that the Extension Programming (Section 4) is correct to allow Line access from the extension.

Note: Even though the Line appears on a station's display or station key, the station must be programmed for access to the Line Group that the CO Line has been programmed in.

CO LINE WON'T RING DIRECTLY TO A STATION

1. Verify that the station can receive an intercom call from another station and is not in DND or call forwarded.
2. Verify current operating mode of IVX (Day, Night, Auto). If Day or Night Modes work correctly, verify Day/Night Table (Function 43).
3. Verify that the CO Line is programmed to the correct station and on the correct ring count (Function 21).

AUTO ATTENDANT WON'T ANSWER

1. Verify that the Lines are ringing at IVX by temporarily ringing to a station.
2. Verify current operating mode of IVX (Day, Night, Auto). If Day or Night Modes work correctly, verify Day/Night Table (Function 43).
3. Verify that the CO Line is programmed to the correct Branch ID and on the correct ring count (Function 21).
4. Verify that the Branch ID has indeed been created (Function 41).
5. Verify that the Branch (probably ID 1) has a recording (Function 61).

STATION INOPERABLE

1. Verify that other stations are working correctly.
2. Replace the phone with another known working phone.
3. Verify all wiring from the block to the phone (including the phone line cord). See Block Wiring Diagram on page 2.7.
4. Verify correct order of wiring.

Note: If the data pairs are reversed, a single character will appear in the phone's display.

5. Connect a known working phone to the block directly behind the system cabinet.
6. Verify in programming that a CO Line can be accessed from the station.

Note: Even though the Line appears on a station's display or station key, the station must be programmed for access to the Line Group that the CO Line has been programmed in.

LOW VOLUME/STATIC/NOISE/CROSS TALK**STATION SPECIFIC**

If the above condition occurs at a single station, see Station Inoperable above.

SYSTEM-WIDE

1. Check the CO Line at the telco demarcation block.
2. Check the wiring from the demarc to IVX.
3. Connect a known working phone to the block directly behind the system cabinet.

FUSES

The Line and extension fuses located on each Port Card are solid state non-replaceable fuses. Each will automatically reset when the fault that caused the fuse to trip has been corrected.

The main power fuse is located on the main board below the disk drive assembly. Before attempting to replace this fuse, contact ESI Technical Support.

TECHNICAL ASSISTANCE

Dealer technical assistance is available 8:00AM to 7:00PM Central Time, Monday thru Thursday and 8:00AM to 5:00 PM on Friday. We require that a qualified telephone repair technician be on-site with the appropriate test equipment for our help.

Enter Programming Mode by pressing PROG/HELP Key, the PARK 3 Key, and the password when prompted.

1 System Programming

11 Initialize

Select Reset or Initialize, confirm with Installer Password.

12 Installer Password

The range is 2 to 8 digits.
Default = 789

13 Administrator Password

The range is 2 to 8 digits.
Default = 456

14 Set Time

Input in a twelve hour format.

15 System Timing Parameters

151 Flash Duration

The range is 2 to 10 (0.2 to 2.0 sec).
Default = 1.5 sec

152 Transfer Recall Timer

The range is 1 to 9 rings.
Default = 3

153 Hold/Park Recall Timer

The range is 5 to 120 seconds.
Default = 60

154 ACD Exit Timer

The range is 5 to 600 seconds.
Default = 180 seconds

153 ACD Wrap Timer

The range is 5 to 600 seconds.
Default = 0 (no limit)

16 Recording Alert

Default = OFF

17 System Speed Dial

Use the input sheet on the following page.

18 Serial Port Baud Rate

The options are: 300, 1200, 2400, 9600, 19.2 or 38.4
Default = 38.4

17 System Speed Dial

LOC	NUMBER	NAME
600		
601		
602		
603		
604		
605		
606		
607		
608		
609		
610		
611		
612		
613		
614		
615		
616		
617		
618		
619		
620		
621		
622		
623		
624		
625		
626		
627		
628		
629		
630		

Use a blank sheet for additional speed dial numbers 631 to 699.

21 CO Line Programming

Day Mode

CO	OUT	Ring 1	Ring 3	Ring 5	Ring 9
Default	9	ID1			
1					
2					
3					
4					
5					
6					
7					
8					
9					
10					
11					
12					
13					
14					
15					
16					

Night Mode

CO	OUT	Ring 1	Ring 3	Ring 5	Ring 9
Default	9	ID1			
1					
2					
3					
4					
5					
6					
7					
8					
9					
10					
11					
12					
13					
14					
15					
16					

22 Toll Restriction Exception Tables

221 Centrex/PBX Access Code Range is 0 to 2 Default = 0 (None)

222 Toll Restriction Exception Tables

Allow numbers: _____

Deny numbers: _____

23 CO Line Parameters

231 Line Receive Volume
The range is 1 to 12. Default = 12

232 Line Open Loop Interval
The range is 1 to 255ms. Default = 6 (60ms)

24 Caller ID

AC to Local 7 _____ AC dialed local 10 _____

31 Station Definition & Routing

EXT	CO	CF DAY	CF NIGHT	PGZN	EXT
	Default	9	To MB	To MB	None
0*	OPERATOR				
100					
101					
102					
103					
104					
105					
106					
107					
108					
109					
110					
111					
112					
113					
114					
115					
116					
117					
118					
119					
120					
121					
122					
123					
124					
125					
126					
127					
128					
129					
130					
131					

* 0 is defaulted Call Fwd and Extension to X100.

32 Station Feature Authorization (Extensions 100 to 115)

EXT	NAME	CALLWAIT	DND	AA BLOCK	REC	SER OB	TOLL
	Default=	Y	Y	N	Y	N	Y
100							
SO LIST:							
101							
SO LIST:							
102							
SO LIST:							
103							
SO LIST:							
104							
SO LIST:							
105							
SO LIST:							
106							
SO LIST:							
107							
SO LIST:							
108							
SO LIST:							
109							
SO LIST:							
110							
SO LIST:							
111							
SO LIST:							
112							
SO LIST:							
113							
SO LIST:							
114							
SO LIST:							
115							
SO LIST:							

32 Station Feature Authorization (Extensions 116 to 131)

EXT	NAME	CALLWAIT	DND	AA BLOCK	REC	SER OB	TOLL
	Default=	Y	Y	N	Y	N	Y
116							
SO LIST:							
117							
SO LIST:							
118							
SO LIST:							
119							
SO LIST:							
120							
SO LIST:							
121							
SO LIST:							
122							
SO LIST:							
123							
SO LIST:							
124							
SO LIST:							
125							
SO LIST:							
126							
SO LIST:							
127							
SO LIST:							
128							
SO LIST:							
129							
SO LIST:							
130							
SO LIST:							
131							
SO LIST:							

33 Departments

EXT	NAME	TYPE*	CF DAY	CF NIGHT	
	Default =		X100	X100	
200					
EXT List:					
201					
EXT List:					
202					
EXT List:					
203					
EXT List:					
204					
EXT List:					
205					
EXT List:					
206					
EXT List:					
207					
EXT List:					
208					
EXT List:					
209					
EXT List:					

* All, In Order, UCD, ACD, Pick-Up.

34 Analog Station Programming

EXT*	TYPE	RING DN	CF DAY	CF NIGHT	TOLLS
	FAX	9	X 0	X 0	YES
	PAGE	NA	NA	NA	
	DOOR	100	ID9999	ID9999	
	RINGER	NA	NA	NA	
	MODEM	9	ID9999	ID9999	YES
	EXT		X 0	X 0	YES

* Default is X191 FAX and X192 Page.

35 Extension Button Mapping

See Programming Section for button default based on the system configuration.

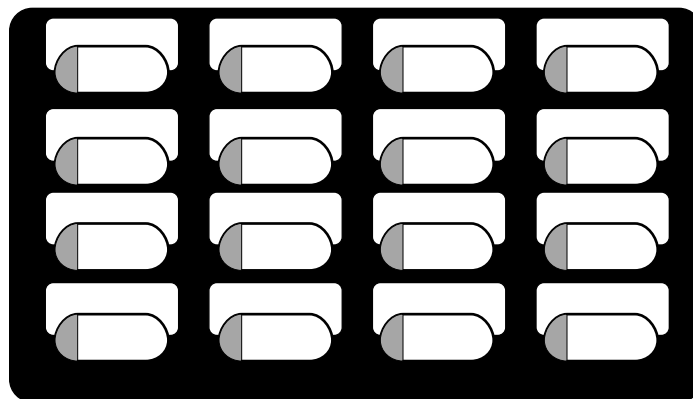

5 Voice Mail Programming

51 Maximum Message Length

The range is 1 to 60 Minutes.
 Default = Messages, 3 Min
 Recordings, 10 Min

Messages Recordings

52 Message Purge

The range is 0 (no purge) to 356 days
 Default = New = 0
 Old = 0
 Group = 0
 Recordings = 0

New Old Group Recordings

53 Guest / Info Mailboxes

MB	NAME	TYPE*	CF DAY**	CF NIGHT**
300				
301				
302				
303				
304				
305				
306				
307				
308				
309				

*The type is either Guest or Info.

**CF Day and Night applies only to Info Mailboxes (default is branch 9999 –disconnect). Use a blank sheet for additional mailboxes.

54 Group Mailboxes (including Broadcast)

List members:

MB	Members
500	All
501	
502	
503	
504	
505	
506	
507	

Use a blank sheet for additional Group mailboxes.

55 External Paging Programming

The pause range is 0 to 9 seconds, the interval range is 10 to 1440 Minutes.

Line Grp Pauses Interval

56 Cascade Paging Mailboxes

List paging numbers and number of pages before the next is added:

MB	1st Number	Times	2nd Number	Times	3rd Number
520					
521					
522					
523					
524					
525					
526					
527					
528					
529					

6 Recording

61 Record System Prompts

62 Record Directory Names

EXT	NAME	KEY*	EXT	NAME	KEY*
100			116		
101			117		
102			118		
103			119		
104			120		
105			121		
106			122		
107			123		
108			124		
109			125		
110			126		
111			127		
112			128		
113			129		
114			130		
115			131		

* Key required if Alpha Directory used. Use blank lines for Guest Extensions.

63 Message On Hold Programming**631 MOH Source**

The range is 590 to 598.

Default = 592 (generic Music on Hold)

632 Record MOH

Record prompts 594 to 598

633 MOH Volume

The range is 1 to 12.

Default = 6

7 Reports**71 Program Configuration****72 Line / Auto Attendant Statistics****73 Extension / Department Statistics****74 Voice Mail Statistics****75 System Speed Dial Report**

A

Access Code for Centrex/PBX.....	4.12
Access User Programming	4.2
ACD (Automatic Call Distributor)	
Agent Operation	PUG.38
Agent Keys	PUG.22
Programming.....	4.20
Tutorial.....	3.9
Add/Delete Mailbox Programming	4.17
Administrator Password	4.6
Agent Log On/Off Key	PUG.22
Agent Operation	PUG.38
Alpha/Numeric Character Entry	4.2
Analog Ports	
Connection	2.10
Programming.....	4.23
Tutorial.....	3.10
Announce Extension Numbers	4.30
Answer Ring	
Programming.....	4.11
Tutorial.....	3.3
Auto Attendant	
Block Feature	4.19
Branch Definitions	3.3
Branch Programming	4.26
Routing Tutorial	3.12
Attendant DSS/BLF Console	
Programming.....	4.17
Using	PUG.42
Automatic Callback.....	PUG.9
Automatic Day/Night Table	
Programming.....	4.30

B

Block Wiring Diagram.....	2.6
Branch	
ID Programming	4.26
ID Tutorial	3.2
Broadcast Mailbox.....	4.35
Button Mapping	4.24

C

Call Forward Key	PUG.17
Call Waiting	PUG.7
Call Pick-up	PUG.7
Caller ID	
Programming.....	4.14
Cascade Paging Mailbox	
Programming.....	4.37
Tutorial.....	3.21
Using	PUG.38
Cautions	2.3
Centrex/PBX Access Code	4.12
Class of Service	4.17
Clock Set.....	4.6
CO Line	
Hardware Connection	2.9
Programming.....	4.9
Tutorial.....	3.1
Conference.....	PUG.6

D

Date Set	4.6
Day/Night Mode	
Automatic Tables	4.30
Tutorial.....	3.16
Key	PUG.22
Delete Entry	4.1
Display	PUG.4
Delayed Ringing (Answer Ring)	
Programming.....	4.11
Tutorial.....	3.3
Department Groups	
Programming.....	4.20
Tutorial.....	3.7
Direct Station Select.....	PUG.3
Directed Call Pick-Up	PUG.7
Directory Branch	
Name Recording.....	4.15
Programming.....	4.28
Tutorial.....	3.17
Disconnect Branch	4.30
DND Key.....	PUG.15
DSS/BLF Console	
Hardware Connection	2.10
Programming.....	4.17
Using	PUG.42

E

Electrical Requirements2.7
 Esi-DexPUG.23
 Expansion Cabinet Installation.....2.12
 Extension
 Button Mapping4.24
 Feature Authorization4.18
 Number Announce4.13
 Programming.....4.16
 Tutorial.....3.6
 External Paging Notification
 Programming.....4.36
 Tutorial.....3.20
 User ProgrammingPUG.27
 UsingPUG.11

F

FAX Extension Programming4.23
 Fixed Feature Keys DescriptionPUG.12
 Flash Hook Duration.....4.7
 Flash/Redial KeyPUG.17
 Fuses2.3

G

General Description1.1
 GoTo Branch
 Programming.....4.26
 Tutorial.....3.12
 Grounding Unit2.7
 Group Mailbox
 Programming.....4.35
 Tutorial.....3.22
 UsingPUG.30
 Guest Mailbox
 Programming.....4.32
 UsingPUG.32

H

Hands Free Answer.....PUG.24
 Hardware Installation2.1
 Headset OperationPUG.23
 Hold KeyPUG.13

I

Information Mailbox Programming4.32
 Initialize System.....4.5
 Installation
 Expansion Cabinet.....2.12
 Grounding2.7
 Mounting Base Cabinet.....2.5
 Port Cards.....2.12
 Intercom CallsPUG.2

K

Keypad Methodology4.1
 Key/PBX Mode4.9

L

LCD DisplayPUG.4
 LED Description2.10
 Line (CO)
 Programming.....4.9
 Tutorial.....3.1
 Line Group Programming.....4.10
 Line KeysPUG.7
 Line Receive Volume.....4.13
 Live Attendant Answering3.2
 Live Outside CallsPUG.28

M

Mailboxes
 Access to.....4.2
 Broadcast.....4.35
 Cascade Paging.....4.37
 Change/Delete User's.....4.15
 Group.....PUG.30
 Guest.....PUG.32
 Main Greeting Recording.....4.37
 Manual Day/Night Mode.....PUG.22
 Maximum Message Length.....4.31
 Menu Branch
 Programming.....4.26
 Tutorial.....3.12
 Message
 Notification.....4.16
 Moving.....PUG.9
 Pause.....PUG.8
 Purging.....4.32
 Reply to.....PUG.8
 Retrieval.....PUG.8
 Ring Notification.....4.15
 Message-On-Hold (MOH)
 Connection.....2.8
 Programming.....4.40
 Volume.....4.41
 Monitor Key.....PUG.16
 Mounting Unit.....2.1
 Moving Messages.....PUG.9
 Mute/DND Key.....PUG.15

N

Name Recording.....4.39
 Night Mode
 Automatic Tables.....4.30
 Tutorial.....3.16
 Key.....PUG.20
 No Response Routing.....4.30

O

Off Premise Transfer Programming.....4.27
 Open Loop Interval.....4.13
 Operator
 Translation Programming.....4.16
 Station Operation.....PUG.28
 Outside Calls.....PUG.2
 Outside Dial Tone Preference.....PUG.24
 Overflow Answering.....3.3

P

Page Key.....PUG.13
 Paging (External)
 Programming.....4.36
 Tutorial.....3.20
 Using.....PUG.11
 User Programming.....PUG.27
 Park Key.....PUG.13
 Password
 User.....PUG.26
 Programming.....4.6
 PBX/Key Mode.....4.9
 Personal Greetings
 Using.....PUG.11
 User Programming.....PUG.20
 Personal Greeting Reminder.....PUG.23
 Pick-Up Key.....PUG.13
 Pick-Up Department Groups.....4.21
 Pick Up of Messages.....PUG.8
 Port Card Installation.....2.12
 Port LED.....2.11
 Power
 Connection.....2.7
 LED.....2.10
 Print Reports.....4.42
 Program / Help Key.....PUG.12
 Programmer Password.....4.6
 Program Mode.....4.3
 Programming Worksheet.....5.1
 Prompt Recording.....4.37
 Purging of Messages.....4.32

Q

Quick Groups.....PUG.14

R

Recall Timer.....4.7
 Record
 Directory Names.....4.39
 Main Greeting.....4.37
 MOH.....4.40
 System Prompts.....4.37
 Recording Alert.....4.7
 Record/Monitor Key.....PUG.16
 Redial Key.....PUG.17
 Regulatory.....2.3
 Report Printing.....4.42

S

Safety2.2

Serial Port

- Connection2.8
- Programming.....4.8

Service Observing.....PUG.22

Soft Feature Keys

- User ProgrammingPUG.20

Station (See Extension)

- Audibles ProgrammingPUG.26
- Connection2.9
- Options ProgrammingPUG.23
- Ringback Programming.....4.6

Speaker KeyPUG.14

System Numbering Plan4.3

System Parameters.....4.5

System Programming Overview4.4

System Speed Dial

- UsingPUG.5
- Programming.....4.8

System Timing Parameters4.7

T

Technical Assistance.....5.4

Time Set.....4.6

Toll Restriction

- Programming.....4.12
- Tutorial.....3.6

Transfer

- To a StationPUG.6
- To a MailboxPUG.6
- To the Main Greeting.....PUG.7
- User to their MailboxPUG.7

Transfer Recall Timer4.7

Trouble Shooting5.1

U

UPS (Uninterrupted Power Source)2.8

User Mailboxes

- Administrator Access to..... 4.19
- Change/Delete4.15

User ProgrammingPUG.20

V

Voicemail KeyPUG.14

Voice Mail

- Operation.....PUG.8
- Programming Section.....4.31
- Tutorial.....3.18

W

Worksheets6.1

Wrap Mode

- ProgrammingPUG.23
- Timers4.7
- UsingPUG.39